

**OWNER'S
MANUAL**

Symphonic

DVD PLAYER with VIDEO CASSETTE RECORDER **WF802**

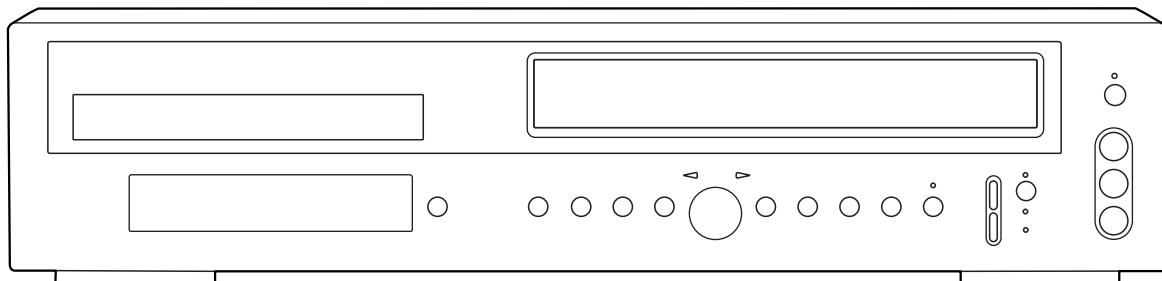

INSTRUCCIONES EN ESPAÑOL INCLUIDAS.

If you need additional assistance for set-up or operating
after reading owner's manual, please call
TOLL FREE : 1-800-242-7158

Please read before using this equipment.

WARNING:

TO REDUCE THE RISK OF FIRE OR ELECTRIC SHOCK, DO NOT EXPOSE THIS APPLIANCE TO RAIN OR MOISTURE.

**CAUTION**

**RISK OF ELECTRIC SHOCK
DO NOT OPEN**



The lightning flash with arrowhead symbol, within an equilateral triangle, is intended to alert the user to the presence of uninsulated “dangerous voltage” within the product’s enclosure that may be of sufficient magnitude to constitute a risk of electric shock to persons.



The exclamation point within an equilateral triangle is intended to alert the user to the presence of important operating and maintenance (servicing) instructions in the literature accompanying the appliance.

CAUTION:

TO REDUCE THE RISK OF ELECTRIC SHOCK, DO NOT REMOVE COVER (OR BACK). NO USER SERVICEABLE PARTS INSIDE. REFER SERVICING TO QUALIFIED SERVICE PERSONNEL.

LASER SAFETY

This unit employs a laser. Only a qualified service person should remove the cover or attempt to service this device, due to possible eye injury.

CAUTION: USE OF CONTROLS OR ADJUSTMENTS OR PERFORMANCE OF PROCEDURES OTHER THAN THOSE SPECIFIED HEREIN MAY RESULT IN HAZARDOUS RADIATION EXPOSURE.

CAUTION: VISIBLE AND INVISIBLE LASER RADIATION WHEN OPEN AND INTERLOCK DEFEATED. DO NOT STARE INTO BEAM.

LOCATION: INSIDE, NEAR THE DECK MECHANISM.

FCC WARNING- This equipment may generate or use radio frequency energy. Changes or modifications to this equipment may cause harmful interference unless the modifications are expressly approved in the instruction manual. The user could lose the authority to operate this equipment if an unauthorized change or modification is made.

CAUTION: TO PREVENT ELECTRIC SHOCK, MATCH WIDE BLADE OF PLUG TO WIDE SLOT, FULLY INSERT.

ATTENTION: POUR ÉVITER LES CHOC ÉLECTRIQUES, INTRODUIRE LA LAME LA PLUS LARGE DE LA FICHE DANS LA BORNE CORRESPONDANTE DE LA PRISE ET POUSSER JUSQU’AU FOND.

IMPORTANT SAFEGUARDS

1. Read Instructions - All the safety and operating instructions should be read before the appliance is operated.
2. Retain Instructions- The safety and operating instructions should be retained for future reference.
3. Heed Warnings - All warnings on the appliance and in the operating instructions should be adhered to.
4. Follow Instructions - All operating and use instructions should be followed.
5. Cleaning - Unplug this video product from the wall outlet before cleaning. Do not use liquid cleaners or aerosol cleaners. Use a damp cloth for cleaning. **EXCEPTION:** A product that is meant for uninterrupted service and, that for some specific reason, such as the possibility of the loss of an authorization code for a CATV converter, is not intended to be unplugged by the user for cleaning or any other purpose, may exclude the reference to unplugging the appliance in the cleaning description otherwise required in item 5.

6. Attachments - Do not use attachments not recommended by the video product manufacturer as they may cause hazards.
7. Water and Moisture- Do not use this video product near water, for example, near a bath tub, wash bowl, kitchen sink, or laundry tub, in a wet basement, or near a swimming pool, and the like.
8. Accessories - Do not place this video product on an unstable cart, stand, tripod, bracket, or table. The video product may fall, causing serious injury to a child or adult, and serious damage to the appliance. Use only with a cart, stand, tripod, bracket, or table recommended by the manufacturer, or sold with the video product. Any mounting of the appliance should follow the manufacturer's instructions and should use a mounting accessory recommended by the manufacturer. An appliance and cart combination should be moved with care. Quick stops, excessive force, and uneven surfaces may cause the appliance and cart combination to overturn.
9. Ventilation - Slots and openings in the cabinet are provided for ventilation and to ensure reliable operation of the video product and to protect it from overheating, and these openings must not be blocked or covered. The openings should never be blocked by placing the video product on a bed, sofa, rug, or other similar surface. This video product should not be placed in a built-in installation such as a bookcase or rack unless proper ventilation is provided or the manufacturer's instructions have been adhered to.



10. Power Sources - This video product should be operated only from the type of power source indicated on the marking label. If you are not sure of the type of power supply to your home, consult your appliance dealer or local power company. For products intended to operate from battery power, or other sources, refer to the operating instructions.
11. Grounding or Polarization - This video product is equipped with a polarized alternating-current line plug (a plug having one blade wider than the other). This plug will fit into the power outlet only one way. This is a safety feature. If you are unable to insert the plug fully into the outlet, try reversing the plug. If the plug should still fail to fit, contact your electrician to replace your obsolete outlet. Do not defeat the safety purpose of the polarized plug.
12. Power Cord Protection - Power supply cords should be routed so that they are not likely to be walked on or pinched by items placed upon or against them, paying particular attention to cords at plugs, convenience receptacles, and the point where they exit from the appliance.
13. Outdoor Antenna Grounding - If an outside antenna or cable system is connected to the video product, be sure the antenna or cable system is grounded so as to provide some protection against voltage surges and built-up static charges. Article 810 of the National Electrical Code, ANSI/NFPA No. 70, provides information with regard to

proper grounding of the mast and supporting structure, grounding of the lead-in wire to an antenna discharge unit, size of grounding conductors, location of antenna-discharge unit, connection to grounding electrodes, and requirements for the grounding electrode. (Fig. A)

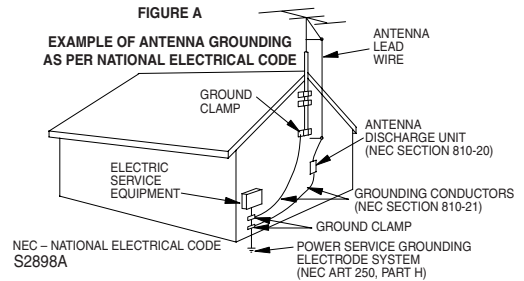

14. Lightning - For added protection for this video product during a lightning storm, or when it is left unattended and unused for long periods of time, unplug it from the wall outlet and disconnect the antenna or cable system. This will prevent damage to the video product due to lightning and power-line surges.
15. Power Lines - An outside antenna system should not be located in the vicinity of overhead power lines or other electric light or power circuits, or where it can fall into such power lines or circuits. When installing an outside antenna system, extreme care should be taken to keep from touching such power lines or circuits as contact with them might be fatal.
16. Overloading - Do not overload wall outlets and extension cords as this can result in a risk of fire or electric shock.
17. Object and Liquid Entry - Never push objects of any kind into this video product through any openings as they may touch dangerous voltage points or short-out parts that could result in a fire or electric shock. Never spill liquid of any kind on the video product.
18. Servicing - Do not attempt to service this video product yourself as opening or removing covers may expose you to dangerous voltage or other hazards. Refer all servicing to qualified service personnel.
19. Damage Requiring Service - Unplug this video product from the wall outlet and refer servicing to qualified service personnel under the following conditions:
 - a. When the power-supply cord or plug is damaged.
 - b. If liquid has been spilled, or objects have fallen into the video product.
 - c. If the video product has been exposed to rain or water.
 - d. If the video product does not operate normally by following the operating instructions. Adjust only those controls that are covered by the operating instructions as an improper adjustment of other controls may result in damage and will often require extensive work by a qualified technician to restore the video product to its normal operation.
 - e. If the video product has been dropped or damaged in any way.
 - f. When the video product exhibits a distinct change in performance this indicates a need for service.
20. Replacement Parts - When replacement parts are required, be sure the service technician has used replacement parts specified by the manufacturer or have the same characteristics as the original part. Unauthorized substitutions may result in fire, electric shock or other hazards.
21. Safety Check - Upon completion of any service or repairs to this video product, ask the service technician to perform safety checks to determine that the video product is in proper operating condition.
22. Heat - This video product should be situated away from heat sources such as radiators, heat registers, stoves, or other products (including amplifiers) that produce heat.

A NOTE ABOUT RECYCLING

This product's packaging materials are recyclable and can be reused. Please dispose of all materials in accordance with your local recycling regulations.

Batteries should never be thrown away or incinerated but disposed of in accordance with your local regulations concerning chemical wastes.

The serial number of this product may be found on the back of the DVD/VCR player. This serial number is unique to your machine. You should record the number and other vital information here and retain this book as a permanent record of your purchase to aid identification in case of theft. Serial numbers are not kept on file.



Date of Purchase	
Dealer Purchase from	
Dealer Address	
Dealer Phone No.	
Model No.	
Serial No.	

ABOUT COPYRIGHT

Unauthorized copying, broadcasting, public performance and lending of discs are prohibited.

This product incorporates copyright protection technology that is protected by claims of certain U.S. patents and other intellectual property rights owned by Macrovision Corporation and other rights owners. Use of this copyright protection technology must be authorized by Macrovision Corporation, and is intended for home and other limited viewing uses only unless otherwise authorized by Macrovision Corporation. Reverse engineering or disassembly is prohibited.

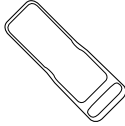
SUPPLIED ACCESSORIES

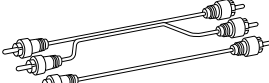
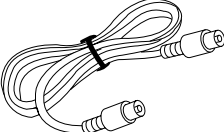
<p>Remote control</p>  <p>(NA200UD)</p>	<p>Two AA batteries</p> 	<p>A/V cables</p>  <p>(approx. 3 feet (100 cm) long) (WPZ0102TM015)</p>	<p>Coaxial Cable</p>  <p>WPZ0901TM002</p>
--	---	--	--

SYMBOLS USED IN THIS MANUAL

The following symbols below appear in some headings and notes in this manual, with the following meanings

VCR

: refers to playback of video cassette tapes.

DVD

: refers to playback of DVD video discs.

CD

: refers to playback of audio CDs.

MP3

: refers to playback of MP3 discs.

TABLE OF CONTENTS

■ LASER SAFETY	2	PLAYING A DVD VIDEO OR AN AUDIO CD	23
■ IMPORTANT SAFEGUARDS	3	USING THE DVD MENUS	23
ABOUT COPYRIGHT	4	USING THE TITLE MENU	24
SUPPLIED ACCESSORIES	4	PAUSING PLAYBACK OR DISPLAYING A STILL PICTURE	24
SYMBOLS USED IN THIS MANUAL	4	RESUMING PLAYBACK FROM THE POINT WHERE PLAYBACK STOPPED	24
■ FEATURES	6	STEPPING THROUGH FRAMES	24
■ PRECAUTIONS	7	FAST FORWARD/REVERSE	25
■ ABOUT THE DISCS	8	SLOW MOTION	25
PLAYABLE DISCS	8	STARTING FROM A DESIRED TRACK	25
DISC TYPES	8	PLAYING FROM A DESIRED TITLE OR A CHAPTER ..	25
■ OPERATING CONTROLS AND FUNCTIONS	9	STARTING FROM A DESIRED TIME COUNT	26
DISPLAY	12	MARKER	26
DISPLAYS DURING OPERATION	12	RANDOM (Audio CD)	26
LOADING THE BATTERIES	12	REPEAT	27
■ VIDEO/DVD SWITCHING	13	A-B REPEAT	27
■ HOOKUPS	14	PROGRAM (Audio CD)	28
DVD/VCR TO TV CONNECTION	14	ZOOM PLAYBACK (enlargement on-screen)	28
SETTING THE CH3/CH4 SWITCH	14	PLAYING AN MP3 DISC	29
CONNECTING TO A TV	14	CHANGING THE ON-SCREEN DISPLAY DURING MP3 DISC PLAY	29
CONNECTING TO A TV THAT HAS AN S-VIDEO INPUT JACK OR COMPONENT VIDEO IN JACKS	14	PLAYING A DESIRED TRACK FROM AN MP3 DISC ..	30
CONNECTING TO AN AMPLIFIER EQUIPPED WITH DIGITAL INPUT JACKS SUCH AS MD DECK OR DAT DECK	15	PLAYING AN MP3 DISC RANDOMLY	30
CONNECTING TO A DOLBY DIGITAL DECODER	16	PLAYING AN MP3 DISC IN A PROGRAM	30
CONNECTING TO AN ANALOG AUDIO	16	■ SETTINGS	31
■ SETUP	17	CHANGING THE AUDIO LANGUAGE OR SOUND MODE	31
AUTOMATIC CHANNEL SET UP	17	CHANGING THE SUBTITLE LANGUAGE	32
TO CHANGE THE ON-SCREEN LANGUAGE	18	CHANGING THE CAMERA ANGLE (Multi-Angle Pictures)	32
CLOCK SET UP	18	CHANGING THE ON-SCREEN DISPLAY	33
■ PLAYBACK FUNCTION	19	BLACK LEVEL SETTINGS	33
NORMAL PLAYBACK	19	■ CHANGING THE SETUP ITEMS	34
AUTO REPEAT PLAYBACK	19	LANGUAGE SETTINGS	34
SEARCH FUNCTIONS	19	DISPLAY SETTINGS	35
■ RECORDING FUNCTION	20	AUDIO SETTINGS	36
VIEWING AND RECORDING THE SAME PROGRAM ..	20	PARENTAL LOCK	37
OTR (One Touch Recording)	20	■ LANGUAGE CODE LIST	38
TIMER RECORDING	20	■ TROUBLESHOOTING GUIDE	39
HINTS FOR TIMER RECORDING	21	■ HANDLING PRECAUTIONS	40
■ SPECIAL FEATURES	22	DISC HANDLING	40
COPYING A VIDEO TAPE	22	■ SPECIFICATIONS	41
MTS (Multi-Channel Television Sound) SYSTEM ..	22		
AUTO REWIND	23		
REAL TIME TAPE COUNTER	23		
■ PLAYING A DISC	23		

INDICE

■ CONTROLES DEL FUNCIONAMIENTO Y SUS FUNCIONES	42
■ CAMBIO DE VCR/DVD	45
■ CONEXIONES	46
DVD/VCR A CONEXIÓN DE TV	46
AJUSTANDO EL CONMUTADOR CH3/CH4	46
CONECTANDO A UN TV	46
CONECTADO A UN TV QUE TIENE TOMA DE ENTRADA DE S-VÍDEO o TOMAS DE ENTRADA DE VÍDEO COMPONENTE ..	46
CONECTANDO A UN AMPLIFICADOR EQUIPADO CON TOMAS DE ENTRADA DIGITAL, TALES COMO PLATINA MD O PLATINA DAT ..	46
CONECTANDO A UN DESCODIFICADOR DIGITAL DOLBY	46
CONECTANDO A UN AUDIO ANALÓGICO	46
■ PREPARACIÓN	46
PREPARACIÓN DE CANAL AUTOMÁTICA	46
PREPARACIÓN DE RELOJ	47
■ REPRODUCCIÓN DE UN DISCO	47
REPRODUCIENDO UN DVD, VIDEO O UN CD AUDIO	47

FEATURES

DVD Mode

● Dolby Digital sound

This player can handle Dolby Digital surround sound with 5.1 channels when connected to a Dolby Digital decoder.

● Still/fast/slow/step playback

Various playback modes are available including still pictures, fast forward/reverse, slow motion and step frames.

● Random playback for audio CD and MP3

This player can shuffle the order of tracks to play them in random order.

● Program playback for audio CD and MP3

You can program the order of tracks to play them in any desired order.

● DVD menus in a desired language

You can display DVD menus in the desired language, if available on the DVD.

● Screen saver/Auto power-off functions

The screen saver program starts when there is no input from the player for five minutes in the stop mode. When the screen saver program has been activated for 30 minutes, the screen saver is automatically turned off.

● Subtitles in a desired language

You can select the desired language for the subtitle display, if that language is available on the disc.

● Selecting a camera angle

You can select the desired camera angle, if the disc contains sequences recorded from different angles.

● Choices for audio language and sound mode

You can select the desired audio language and sound mode, if different languages and modes are available on the disc.

● Parental lock

You can set the control level to limit playback of discs which may not be suitable for children.

● Automatic detection of discs

This player automatically detects if the loaded disc is DVD, audio CD or MP3 on disc.

● Playing an MP3 disc

You can enjoy MP3 files which are recorded on CD-R/RW.

● Direct Search

You can search for the desired title, chapter, and track with the Number buttons during playback or in stop mode.

● On-screen display

Information about the current operation can be displayed on the TV screen, allowing you to confirm the currently active functions (such as program playback), on the TV screen using the remote control.

● Search

Chapter search: Search for a chapter designated by user is possible.

Title search: Search for a title designated by user is possible.

Track search: Search for a track designated by user is possible.

Time search: Search for a time designated by user is possible.

● Repeat

Chapter: Repeated playback of the chapter of the disc being played is possible.

Title: Repeated playback of the title of the disc being played is possible.

Track: Repeated playback of the track of the disc being played is possible.

Disc (audio CD): Repeated playback of the entire disc being played is possible.

A-B: Playback of the section between A and B (designated by user) is possible.

Album: Repeated playback of the album of the MP3 disc being played is possible.

● Zoom

A $\times 2$ and $\times 4$ magnified screen can be displayed.

● Marker

A part designated by user can be called back.

● Resume Play

User can resume playback from the part at which the play was stopped even if the power is turned off.

● Dimmer

Brightness of the display can be varied.

● Bit rate indication

● DRC (Dynamic range control)

You can control the range of sound volume.

VCR Mode

Hardware specifications

- **Auto Head Cleaner**
- **4 Head HiFi Stereo**
- **Bilingual on-screen menu display selectable in English, French, or Spanish**
- **181 channel capability PLL frequency synthesizer tuner with direct station call**
(A cable converter box may be necessary to view scrambled cable channels.)

Automatic functions

- **Auto power on system**
Automatically turns the DVD/VCR on when you insert the cassette.
- **Digital Auto Tracking (DTR)**

Playback

- **S-VHS Quasi Playback (SQPB)**
(Allows you to view a tape recorded in S-VHS format.)
- **Auto Repeat**
- **2 Step Picture Search Operation**
- **Index Search**
- **Time Search**

Recording

- **1 Year, 7 events (including Daily and Weekly Timer Recording)**
- **OTR (One Touch Recording)**

PRECAUTIONS

INSTALLATION LOCATION

For safety and optimum performance of your DVD/VCR:

- Install the DVD/VCR in a horizontal and stable position. Do not place anything directly on top of the DVD/VCR. Do not place the DVD/VCR directly on top of the TV.
- Shield it from direct sunlight and keep it away from sources of intense heat. Avoid dusty or humid places. Avoid places with insufficient ventilation for proper heat dissipation. Do not block the ventilation holes on the sides of the DVD/VCR. Avoid locations subject to strong vibration or strong magnetic fields.

AVOID THE HAZARDS OF ELECTRICAL SHOCK AND FIRE

- Do not handle the power cord with wet hands.
- Do not pull on the power cord when disconnecting it from AC wall outlet. Grasp it by the plug.
- If, by accident, water is spilled on your DVD/VCR, unplug the power cord immediately and take the unit to our Authorized Service Center for servicing.
- Do not put your fingers or objects into the DVD/VCR cassette holder.



MOISTURE CONDENSATION WARNING

Moisture condensation may occur inside the unit when it is moved from a cold place to a warm place, or after heating a cold room or under conditions of high humidity. Do not use the DVD/VCR at least for 2 hours until its inside is dry.

ABOUT THE DISCS

PLAYABLE DISCS

The following discs can be played back on this DVD/VCR.

Disc Type	Logo	Contents	Disc Size	Maximum Playback Time
DVD Video		Sound and Pictures	12 cm	Approx. 4 h (single-sided)
				Approx. 8 h (double-sided)
			8 cm	Approx. 80 min (single-sided)
				Approx. 160 min (double-sided)
Audio CD		Sound	12 cm	74 min
			8 cm (singles)	20 min

This player conforms to the NTSC color system. You cannot play discs recorded in other color systems such as PAL or SECAM.

- Some discs include region codes as shown below.



- The number inside the symbol refers to a region of the world, and a disc encoded in a specific region format can only be played back on DVD/VCR with the same region code.

The following discs cannot be played back on this DVD/VCR.

- DVD with region codes other than 1 or ALL.
- DVD-ROM
- DVD-RAM (Never attempt to play back, otherwise a malfunction may result.)
- CD-ROM
- VSD
- CDV (Only plays back the audio part.)
- CD-G (Only plays back the sound.)
- CD-R/CD-RW (Only plays back discs on which audio CD or MP3 are recorded.)
- CD-I (Never attempt to play back, otherwise a malfunction may result.)
- SACD
- Photo CD (Never attempt to play back, otherwise a malfunction may result.)
- Video CD (Never attempt to play back, otherwise a malfunction may result.)

Any other discs without compatibility indications

DISC TYPES

[DVD]

Data on a DVD is divided into sections called "titles", and then into subsections called "chapters", each of which is given a title or chapter number. Playback conditions are preset on some DVD video discs, and these playback conditions take priority over user operations on this player. If a function you selected does not run as desired, refer to the manual accompanying the disc.

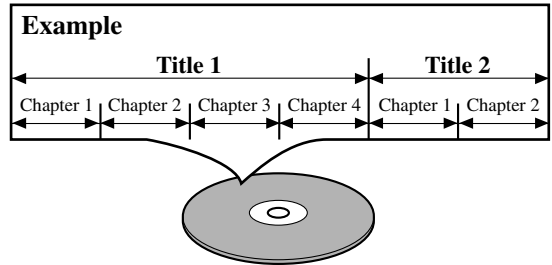

[AUDIO CD]

Data on an audio CD is divided into sections called "tracks", each of which is given a track number.

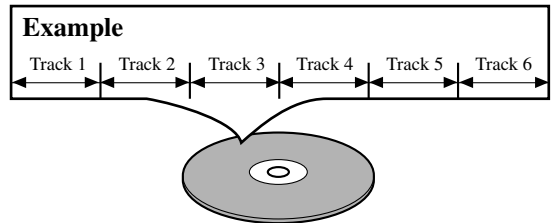

[MP3]

Data on an MP3 is divided into sections called "albums", and then into subsections called "tracks", each of which is given an album or track number.

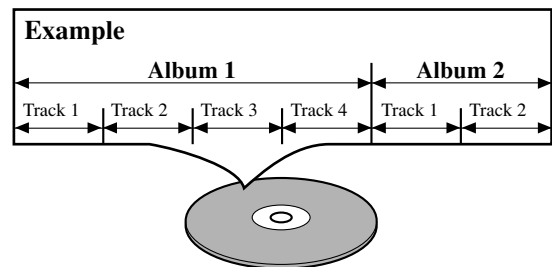

OPERATING CONTROLS AND FUNCTIONS

FRONT PANEL

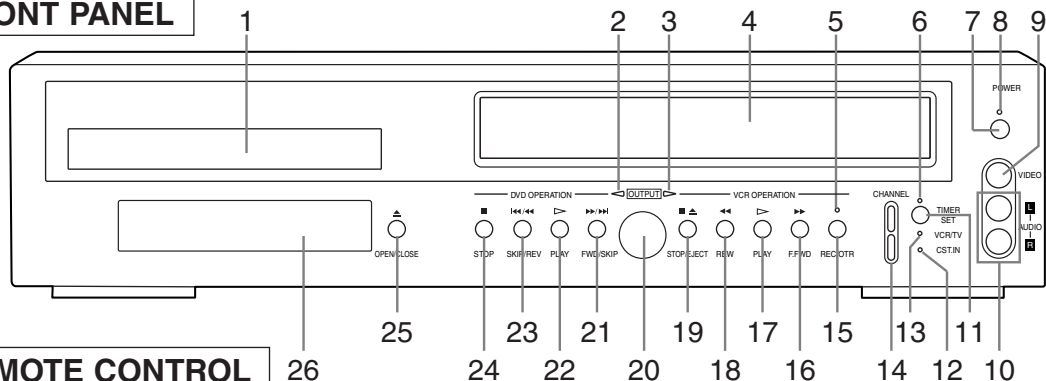

REMOTE CONTROL

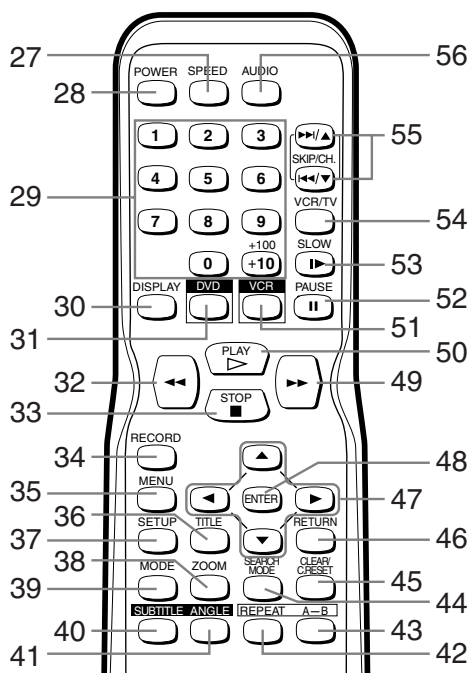

1. Disc loading tray

2. DVD OUTPUT Light (Green) [page 13]

This light appears when the DVD output mode is selected. You can only watch DVDs when the green DVD OUTPUT Light is on. To make the green DVD OUTPUT light come on, press the DVD button on the remote control or the OUTPUT button on the front panel.

3. VCR OUTPUT Light (Green) [page 13]

This light appears when the VCR output mode is selected. You can only watch tapes when the green VCR OUTPUT light is on. To make the green VCR OUTPUT light come on, the VCR button on the remote control or the OUTPUT button on the front panel.

4. CASSETTE COMPARTMENT

5. REC/OTR Light [page 20]

Lights up during recording.

6. TIMER SET Light [page 20]

This light glows when the DVD/VCR is in standby mode or off for a timer recording or during a One-Touch Recording. It flashes if the TIMER SET button is pressed for a timer recording, but there is no

tape in the DVD/VCR. It flashes when all timer recordings or One-Touch Recordings are finished.

7. POWER Button [page 17]

Press to turn the power on and off.

8. POWER Light

Lights up when the power is on.

9. VIDEO In Jack

Connect a video cable coming from the video out jack of a camcorder, another VCR, or a video source (laser disc player, camcorder, etc.) here.

10. AUDIO In Jacks

Connect audio cables coming from the audio out jacks of a camcorder, another VCR, or an audio source here.

11. TIMER SET Button [page 21]

Press to put the DVD/VCR into standby mode for a timer recording.

12. CST IN Light [page 19]

Lights up when a cassette is in the DVD/VCR.

13. VCR/TV Light [page 17]

Lights up when the DVD/VCR is in the VCR position, and goes off when it is in the TV position.

14. CHANNEL Buttons [page 17]

In VCR mode, press to change TV channels on the DVD/VCR; press to adjust the tracking during normal or slow motion playback; press to remove vertical jitter in a Still picture.

15. REC/OTR Button (VCR) [page 20]

Press once to start a recording. Press repeatedly to start a One-Touch Recording.

16. F.FWD Button (VCR) [page 17]

Press to rapidly advance the tape, or view the picture rapidly in forward during playback. (Forward Search). When setting program (For example: setting clock or timer program), press to determine your selection and proceed to the next step you want to input. Press to determine the setting modes from the on screen menu. Press to add or delete channel numbers during channel preset.

17. PLAY Button (VCR) [page 17]

Press to begin playback. Press to enter digits when setting program (For example: setting clock or timer program). Press to select the setting modes from the on screen menu.

18. REW Button (VCR) [page 18]

Press to rewind the tape, or to view the picture rapidly in reverse during the playback mode (Rewind Search). Press to cancel a setting of timer program. Press to correct digits when setting program (For

example: setting clock or timer program). Press to add or delete channel numbers during channel preset.

19. **STOP/EJECT Button (VCR) [page 21]**

● **EJECT Button**

Press to remove the tape from the VCR.

● **STOP Button**

Press to stop the tape motion. Press to enter digits when setting program (For example: setting clock or timer program). Press to select the setting modes from the on screen menu.

20. **OUTPUT Button [page 13]**

Press to select DVD mode or VCR mode.

● You can switch the output mode either by pressing the OUTPUT button on the front panel, or by pressing the DVD or the VCR button on the remote control. However, **if you press the OUTPUT button on the front panel first, you need to re-select the corresponding mode by pressing the DVD or the VCR button on the remote control.**

21. **FWD/SKIP Button (DVD) [page 25]**

Plays back from the beginning of the next chapter or track. Hold down to fast forward playback.

22. **PLAY Button (DVD) [page 23]**

Press to begin playback.

23. **SKIP/REV Button (DVD) [page 25]**

Plays back from the beginning of the current chapter or track. Hold down to fast reverse playback.

24. **STOP Button (DVD) [page 23]**

Stops operation of the disc.

25. **OPEN/CLOSE Button [page 23]**

Press to insert discs into or remove them from the tray.

26. **Display, Remote Sensor Window**

27. **SPEED Button [page 20]**

Press to select the VCR's recording speed (SP or SLP)

28. **POWER Button**

Press to turn the power on and off.

29. **Number Buttons**

● **DVD mode [page 25]**

Press to directly select a Track (Audio CD) for playback.

Press to program Tracks (Audio CD) for playback.

● **VCR mode [page 17]**

Press to select TV channels on the DVD/VCR.

To select channels, enter channel numbers as a two-digit number for the quickest results. For example, to select channel 6, press 0 then 6.

+100 Button:

If you want to select channels 100 and above, press this button first, then press the last two digits. For example, to select channel 125, press +100 button first, then press 2 and 5.

30. **DISPLAY Button**

● **DVD mode [page 29]**

Press to access or remove the display screen during DVD or Audio CD playback.

● **VCR mode [page 22]**

Press to access or remove the VCR's on-screen status display.

31. **DVD Button [page 13]**

Press to select DVD mode for the remote control.

● You can switch the OUTPUT mode either by pressing the OUTPUT button on the front panel, or by pressing the DVD or the VCR button on the remote control. However, **if you press the OUTPUT button on the front panel first, you need to re-**

select the corresponding mode by pressing the DVD or the VCR button on the remote control.

32. **◀◀ Button**

● **DVD mode**

Press to view the DVD picture in fast reverse motion or to reverse playback of an Audio CD.

● **VCR mode**

Press to rewind the tape, or to view the picture rapidly in reverse during the playback mode (Rewind Search). Press to cancel a setting of timer program. Press to correct digits when setting program (For example: setting clock or timer program). Press to add or delete channel numbers during channel preset.

33. **STOP Button**

● **DVD mode**

Press to stop the disc motion.

● **VCR mode**

Press to stop the tape motion. Press to enter digits when setting program (For example: setting clock or timer program). Press to select the setting modes from the on screen menu.

34. **RECORD Button**

Press to start a recording.

35. **MENU Button**

● **DVD mode [page 23]**

Press to display the menu of the Disc.

● **VCR mode [page 17]**

Press to access the VCR menu.

36. **TITLE Button [page 24]**

37. **SETUP Button [page 34]**

Press to enter the setup mode.

38. **ZOOM Button [page 28]**

Enlarges part of a DVD-reproduced image.

39. **MODE Button [pages 19]**

Activates program playback or random playback mode when playing CDs or MP3. Sets Black level.

40. **SUBTITLE Button [page 32]**

Press to select the desired subtitle language.

41. **ANGLE Button [page 32]**

Press to change the camera angle to see the sequence being played back from a different angle.

42. **REPEAT Button [page 27]**

Repeats playback of the current disc, title, chapter or track.

43. **A-B REPEAT Button [page 27]**

Repeats playback of a selected section.

44. **SEARCH MODE Button**

● **DVD mode [page 25]**

Press to access or remove the Search display, which allows you to go directly to a specific Title/Chapter/Track/Time.

● **VCR mode [page 19]**

Press to perform a Time Search or an Index Search.

45. **CLEAR/C.RESET Button**

● **DVD mode [page 26]**

Press to reset the setting.

● **VCR mode [page 18]**

Press to reset the counter. Press to exit from the MENU screen.

46. **RETURN Button**

Returns to the previous operation.

47. **Arrow Buttons**

Use when making settings while watching the display on a TV screen.

48. **ENTER Button**

Press to accept a setting.

49. **▶▶ Button**

● **DVD mode**

Press to fast forward the Disc. Press the Pause button, then press the FWD button to begin slow motion playback. Press the FWD button repeatedly to change the forward speed of slow motion.

● **VCR mode**

Press to rapidly advance the tape, or view the picture rapidly in forward during playback (Forward Search). When setting program (For example: setting clock or timer program), press to determine your selection and proceed to the next step you want to input. Press to determine the setting modes from the on screen menu. Press to add or delete channel numbers during channel preset.

50. **PLAY Button**

● **DVD mode**

Press to begin playback.

● **VCR mode**

Press to begin playback. Press to enter digits when setting program (For example: setting clock or timer program). Press to select the setting modes from the on screen menu.

51. **VCR Button [page 13]**

Press to select VCR mode for the remote control.

● You can switch the OUTPUT mode either by pressing the OUTPUT button on the front panel, or by pressing the DVD or the VCR button on the remote control. However, **if you press the OUTPUT button on the front panel first, you need to re-select the corresponding mode by pressing the DVD or the VCR button on the remote control.**

52. **PAUSE Button**

● **DVD mode [page 24]**

Press to pause Disc playback. Press repeatedly to advance the DVD picture step by step (or one frame at a time).

● **VCR mode [page 19]**

While recording, press to temporarily stop the recording (pause). Press a second time to resume normal recording. You can not pause a One-Touch Recording. Or, press during tape playback to freeze the picture. Press to advance the picture one

frame at a time during still mode.

53. **SLOW Button [page 19]**

During tape playback, press to view the video tape in slow motion. Press again to resume normal playback. This button does not affect DVD playback.

54. **VCR/TV Button [page 21]**

Use to select VCR or TV position. If the VCR/TV light appears on the front of the DVD/VCR, it is in VCR position (in either VCR or DVD mode). If the VCR/TV light doesn't appear on the front of the DVD/VCR, it is in TV position.

● **VCR Position**

When the green VCR OUTPUT light appears on the front of the DVD/VCR, use the VCR to watch a tape, watch a TV program while recording it, or watch a TV broadcast using the CHANNEL or the Number buttons to change channels at the DVD/VCR.

When the green DVD OUTPUT light appears on the front of the DVD/VCR, use the DVD/VCR to view Disc playback or menus.

● **TV Position**

Use to watch TV (changing channels at the TV) or watch one program while recording another.

55. **SKIP/CH. Buttons**

● **DVD mode**

Press to skip Chapters or Tracks.

● **VCR mode**

Press to change TV channels on the DVD/VCR.

56. **AUDIO Button [page 31]**

Press to select a desired audio language or sound mode.

57. **AC Power Cord**

Notes

● To use the remote control to operate the DVD/VCR and its features, press the DVD button on the remote control before pressing other DVD buttons. Verify that the green DVD OUTPUT Light is on.

● To use the remote control to operate the VCR and its features, press the VCR button on the remote control before pressing other VCR buttons. Verify that the green VCR OUTPUT Light is on.

REAR VIEW

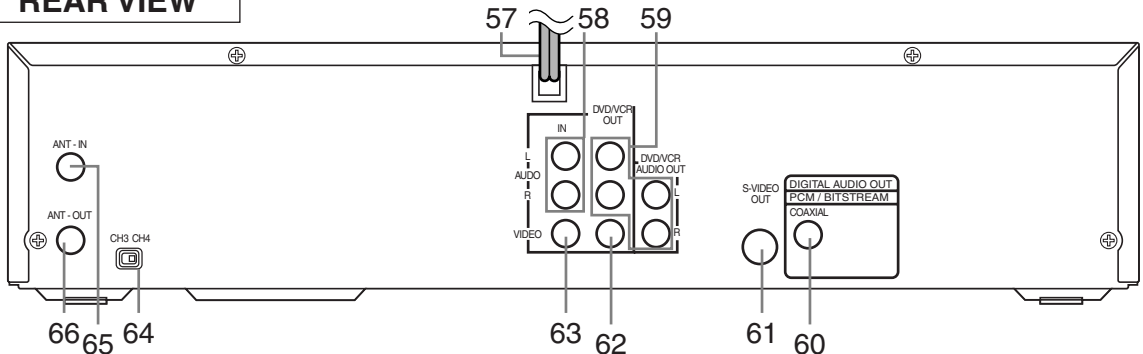

Connect to a standard AC outlet to supply power to the DVD/VCR.

58. **AUDIO IN Jacks**

Connect audio cables coming from the audio out jacks of a camcorder, another VCR, or an audio source here.

59. **DVD/VCR AUDIO OUT Jacks**

Connect the supplied audio cables here and to the Audio In jacks of a television or other audio equipment.

60. COAXIAL Jack

Connect an optional coaxial digital audio cable here and to the Coaxial Digital Audio In jack of a decoder or audio receiver.

61. S-VIDEO OUT Jack

Connect an optional S-Video cable here and to the S-Video In jack of a television.

62. DVD/VCR VIDEO OUT Jack

Connect the yellow video cable (supplied) here and to the TV's Video In jack.

63. VIDEO IN Jack

Connect a cable coming from the video out jack of a camcorder, another VCR, or an audio-visual source (laser disc player, video disc player, etc.) here.

64. CH3/CH4 Switch

Set to channel 3 or 4 to use your TV with your DVD/VCR.

65. ANT-IN (Antenna In) Jack

Connect your antenna, Cable Box, or Direct Broadcast System.

66. ANT-OUT (Antenna Out) Jack

Use the supplied RF coaxial cable to connect this jack to the ANTENNA IN Jack on your TV.

Notes

- The S-VIDEO OUT jack, COAXIAL jack, and OPTICAL jack are only useful in DVD mode.

DISPLAY

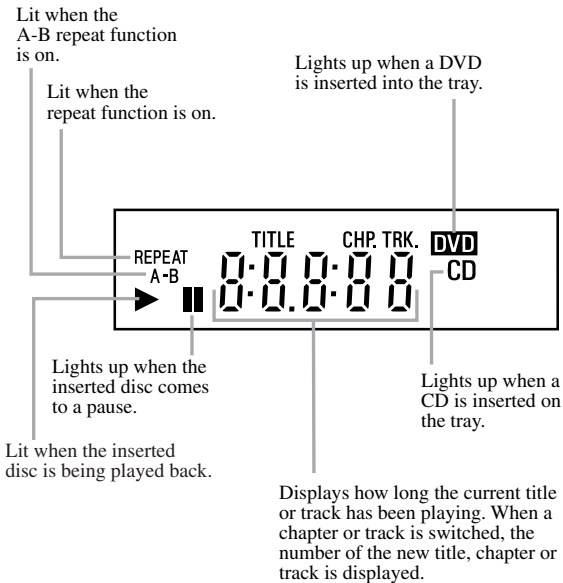

DISPLAYS DURING OPERATION

	Power on
	No disc inserted
	Tray open
	Tray closed
	Loading the Disc
	Power off

LOADING THE BATTERIES

1. Open the battery compartment cover.
2. Insert two AA batteries, with each one oriented correctly.
3. Close the cover.

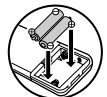

Notes

- Do not mix alkaline and manganese batteries.
- Do not mix old and new batteries.

VCR/DVD SWITCHING

Since this product comprises VCR and DVD players, it is necessary to select the correct output mode.

SWITCHING TO VCR MODE

Press the VCR button on the remote control.
(Verify that the VCR OUTPUT Light is lit.)

SWITCHING TO DVD MODE

Press the DVD button on the remote control.
(Verify that the DVD OUTPUT Light is lit.)

Notes

- Pressing only the OUTPUT button on the front panel does not switch the mode of the remote control. You always need to select the correct mode on the remote control too.

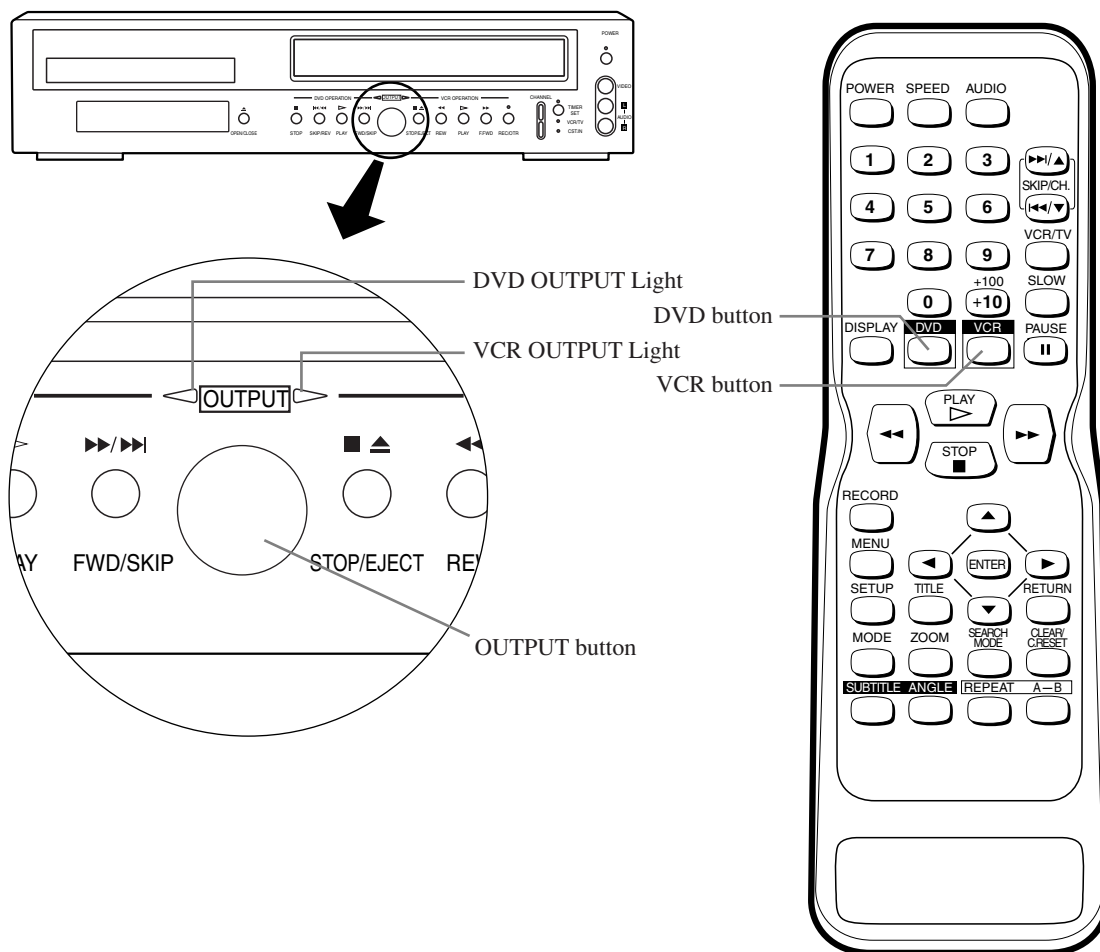

HOOKUPS

DVD/VCR TO TV CONNECTION

1. Disconnect the AC power cord of the TV from the AC outlet.
2. Disconnect the antenna or cable from the TV.
3. Connect the antenna or cable to the ANT-IN jack of the DVD/VCR.
4. Connect the DVD/VCR to the TV using the coaxial cable.
5. Plug the AC power cords of the DVD/VCR and TV into the AC outlets.

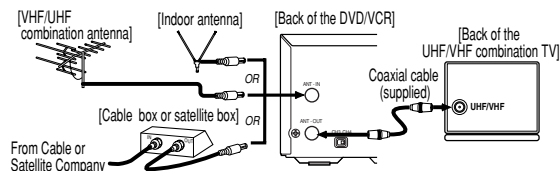

SETTING THE CH3/CH4 SWITCH

If your TV does not have A/V terminals:

When the DVD/VCR is in the VCR Playback mode or when the DVD/VCR is in the VCR mode, your TV will receive signals from the DVD/VCR on either channel 3 or channel 4. To use the DVD/VCR with your TV, set the selector switch to CH3 or CH4 (which is located in the back of your DVD/VCR), whichever is not used for normal broadcasts in your area. Then set your TV to the same channel.

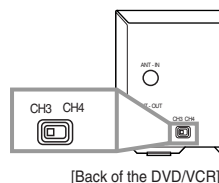

Note to CATV system installer

This reminder is provided to call the CATV system installer's attention to Article 820-40 of the NEC that provides guidelines for proper grounding and, in particular, specifies that the cable ground should be connected to the grounding system of the building, as close to the point of cable entry as practical.

CONNECTING TO A TV

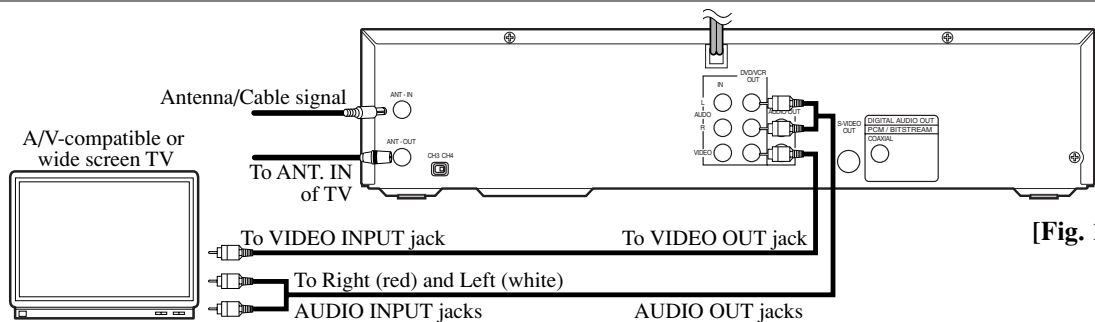

[Fig. 1]

Notes

- Connect the DVD/VCR directly to a TV. If the A/V cables are connected to a VCR, pictures may be distorted due to the copy protection system.

CONNECTING TO A TV THAT HAS AN S-VIDEO INPUT JACK OR COMPONENT VIDEO IN JACKS

FOR TVs WITH S-VIDEO INPUT JACK

Use an S-Video cable (commercially available) in place of the yellow video cable to enjoy higher quality pictures.

The S-Video connection only supplies video (picture) in the DVD mode of the DVD/VCR. Therefore, in order to use the VCR features or view TV channels on the DVD/VCR, you still need to either connect the RF coaxial cable between the ANT-OUT jack of the DVD/VCR and the TV's Antenna In jack, or connect the yellow video cable as described earlier (Fig.1). To connect the supplied RF coaxial cable, see "DVD/VCR TO TV CONNECTION" above.

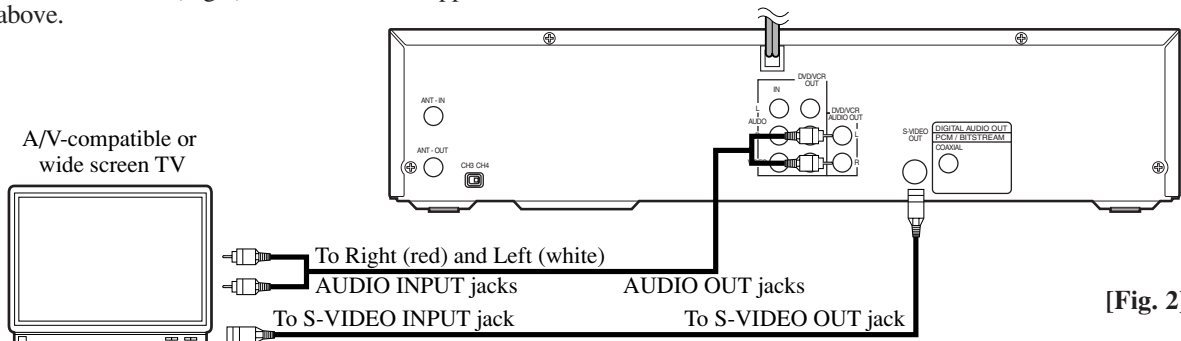

[Fig. 2]

CONNECTING TO AN AMPLIFIER EQUIPPED WITH DIGITAL INPUT JACKS SUCH AS MD DECK OR DAT DECK

Use an audio coaxial digital cables (not included) for the audio connections.

Connecting to an amplifier equipped with digital input jacks such as MD Deck or DAT Deck.

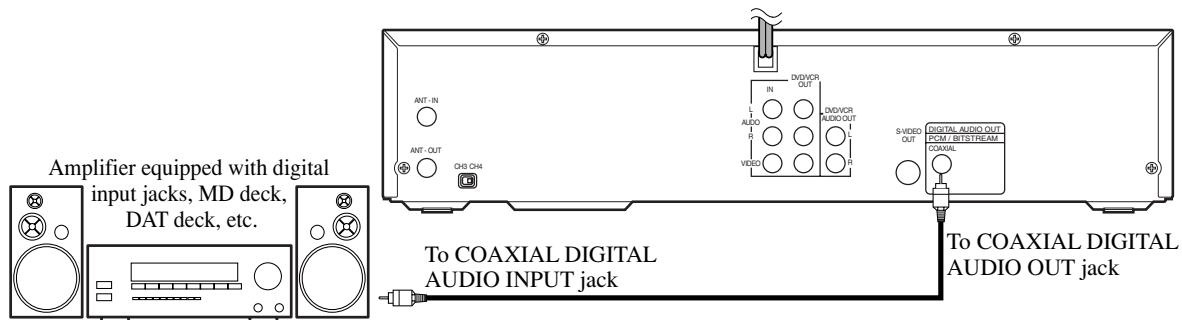

[Fig. 4]

Notes

- The audio source on a disc in the 5.1 channel Dolby Digital surround format cannot be recorded as digital sound by an MD or DAT deck.
- Be sure to turn off the power to all components in the system before connecting another component.
- Refer to the Owner's Manuals for the components to be connected to the DVD/VCR.
- Set Dolby Digital to off for audio output in the setup mode. Playing a DVD disc using incorrect settings may generate noise distortion, and may also damage the speakers. (See page 36 to set Dolby Digital to on)

CONNECTING TO A DOLBY DIGITAL DECODER

If using this DVD/VCR to play a DVD disc in 5.1 channel Dolby Digital surround formats, the DVD/VCR outputs a Dolby Digital data stream from its COAXIAL DIGITAL AUDIO OUT jack. By hooking the DVD/VCR up to a Dolby Digital decoder, you can enjoy a more convincing, realistic ambience with powerful and high-quality surround sound of a professional standard such as can be heard in movie theaters.

Use an audio coaxial digital cables (not included) for the audio connections.

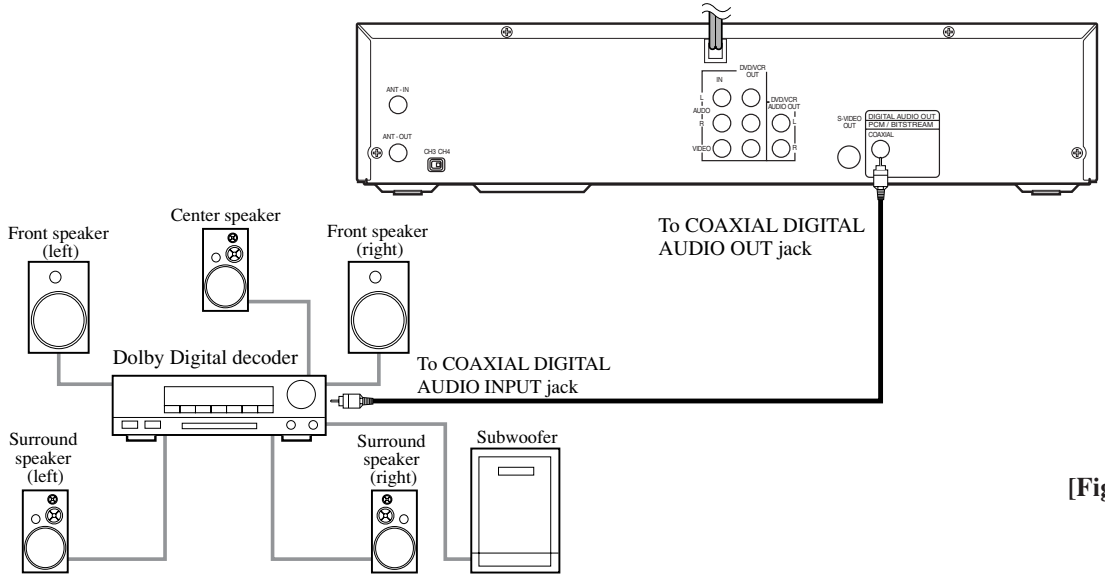

[Fig. 5]

Notes

- Be sure to turn off the power to all components in the system before connecting another component.
- Refer to the Owner's Manuals for the components to be connected to the DVD/VCR.
- If the output is Dolby Digital audio, connect to a Dolby Digital decoder, and set Dolby Digital to on for audio output in the setup mode.
- Unless connected to a Dolby Digital decoder, set Dolby Digital to off for audio output in the setup mode. Playing a DVD using incorrect settings may generate noise distortion, and may also damage the speakers.

Manufactured under license from Dolby Laboratories. "Dolby" and the double-D symbol are trademarks of Dolby Laboratories.

CONNECTING TO AN ANALOG AUDIO

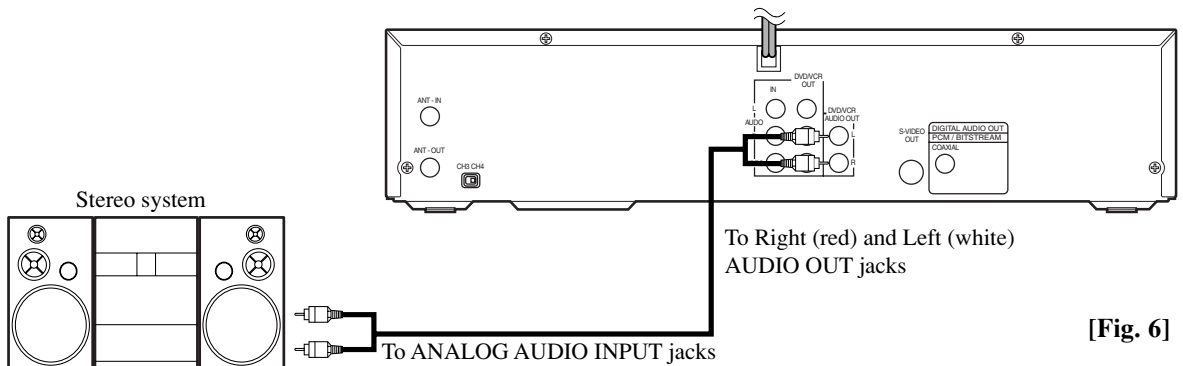

[Fig. 6]

Notes

- Be sure to turn off the power to all components in the system before connecting another component.
- Refer to the Owner's Manuals for stereo systems and any other components to be connected to the DVD/VCR.

SETUP

AUTOMATIC CHANNEL SET UP

VCR

The DVD/VCR can automatically program the tuner to scan only the channels which are available in your area.

- Channel memory programming is NOT needed when the DVD/VCR is connected to a cable box or a satellite box as in "DVD/VCR TO TV CONNECTION" on page 14. In this case, set the CH3/CH4 Switch (which is located on the back of your VCR) to either CH3 or CH4, whichever is not used for normal broadcasts in your area. Then set your TV to the same channel. The channel you want to record or view will be selected from the cable or the satellite box.
- Follow the steps below once. Repeat only if there is a power failure or if the DVD/VCR is unplugged for more than 30 seconds. (In these cases, the programmed channels are erased.)
- You must follow the steps below before attempting to play or record a video tape.

1 You need to connect the antenna or cable to the DVD/VCR first. Then, connect the DVD/VCR power plug to a standard AC outlet.

2 Turn on the TV and set the TV to channel 3 or 4.

- Now set the CH3/CH4 switch on the back of the DVD/VCR to match the channel selected on the TV.

3 Turn on the DVD/VCR by pressing the POWER button. Both the POWER and the VCR/TV light will come on.

4 Select the On Screen Language ("ENGLISH", "FRANCAIS" or "ESPAÑOL") by pressing the PLAY or the STOP button. Then, press the F.FWD button.

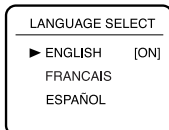

5 Begin channel preset by pressing the F.FWD button once. The tuner scans and memorizes all active channels in your area.

- The DVD/VCR distinguishes between standard TV channels and cable channels.

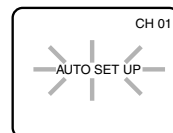

6 After scanning, the tuner stops on the lowest memorized channel. The TV screen returns to TV mode.

- If "AUTO SET UP" appears on the TV screen again, check the cable connections. Press the F.FWD button once again and the DVD/VCR will begin preset again.

TO SELECT A DESIRED CHANNEL

You can select the desired channel by using the CHANNEL buttons (▲/▼) or by directly pressing the Number buttons on the remote control.

Note for using the Number buttons:

- When selecting cable channels which are higher than 99, press the +100 button first, then press the last two digits.
- You must precede single-digit channel numbers with a zero (For example: 02, 03, 04 and so on).

TO PRESET THE CHANNELS AGAIN

1 Press the MENU button until the main menu appears. (If you have already set the clock, you only have to press it once. If not, you have to press it twice).

2 Select "CHANNEL SET UP" by pressing the PLAY or the STOP button. Then, press the F.FWD button.

3 Select "AUTO SET UP" by pressing the PLAY or the STOP button. Then, press the F.FWD button.

- After scanning, the tuner stops on the lowest memorized channel.

TO ADD/DELETE CHANNELS

When scanning, some channels may be skipped due to a weak signal. In such cases, you can add the channels to the DVD/VCR memory manually.

- 1 Press the MENU button until the main menu appears. (If you have already set the clock, you only have to press it once. If not you have to press it twice).

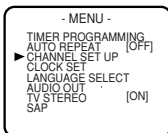

- 2 Select "CHANNEL SET UP" by pressing the PLAY or the STOP button. Then, press the F.FWD button.

- 3 Select "MANUAL SET UP" by pressing the PLAY or the STOP button. Then, press the F.FWD button.

- 4 Enter the desired channel number by pressing the PLAY or the STOP button.

- 5 Add or Delete it from memory by pressing the F.FWD or the REW button so that "ADD" or "DELETE" flashes on the TV screen accordingly.

- 6 Exit the Preset mode by pressing the CLEAR/C.RESET button.

TO CHANGE THE ON-SCREEN LANGUAGE

VCR

- 1 Press the MENU button twice to call up the main menu. (If you have already set the clock, you only have to press it once).

- 2 Select "LANGUAGE SELECT" by pressing the PLAY or the STOP button. Then, press the F.FWD button.

- 3 Select "ENGLISH", "FRANCAIS" or "ESPAÑOL" by pressing the PLAY or the STOP button. Then, press the CLEAR/C.RESET button.

CLOCK SET UP

VCR

Set the clock accurately for proper automatic timer recording. We suggest that you use a TV or radio station as your time source.

- 1 Press the MENU button twice to call up the main menu. (If you have already set the clock, you only have to press it once).

- If the clock is not set, the CLOCK SET menu appears first. In this case, follow step [3].

- 2 Select "CLOCK SET" by pressing the PLAY or the STOP button. Then, press the F.FWD button

- 3 Set the clock.

1) Set the month

Press the PLAY button or the STOP button repeatedly. Then, press the F.FWD button.

2) Set the day

Press the PLAY button or STOP repeatedly. Then, press the F.FWD button.

3) Set the year

Press the PLAY button or the STOP button repeatedly. Then, press the F.FWD button. The day of the week will appear automatically.

4) Set the hour

Press the PLAY button or the STOP button repeatedly. Then, press the F.FWD button.

5) Set the minute

Press the PLAY button or the STOP button repeatedly. Then, press the F.FWD button.

6) Set AM or PM

Press the PLAY button or the STOP button repeatedly.

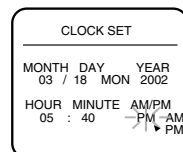

- To go back one step, press the REW button.

- 4 Start the clock by pressing the CLEAR/C.RESET or the F.FWD button.

PLAYBACK FUNCTION

NORMAL PLAYBACK

VCR

- 1 Insert a prerecorded tape. The DVD/VCR will turn on, and the VCR/TV Light and the CST IN Light comes on.

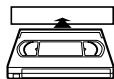

- If the safety tab has been removed, the DVD/VCR will start playback automatically.

- 2 Turn on the TV and set the TV to channel 3 or 4.

- Now set the CH3/CH4 switch on the back of the DVD/VCR to match the channel selected on the TV.

- 3 Begin playback by pressing the PLAY button.

- Tracking adjustment will be done automatically (Digital Tracking function) when you start playback. To adjust the tracking manually, press the CHANNEL buttons (▲/▼) on the DVD/VCR.
- When a tape has reached the end, the DVD/VCR will automatically rewind the tape to the beginning, and eject the tape.
- S-VHS Quasi Playback (SQPB): This unit allows you to view a tape recorded in S-VHS format. (Noise lines may appear on the picture.)

- 4 To stop playback, press the STOP button.

PAUSE/STILL/SLOW

You can freeze the picture on TV screen by pressing the PAUSE button during playback.

- You can advance the picture one frame at a time by pressing the PAUSE button during the Still mode.
- If the picture begins to vibrate vertically during the still mode, stabilize the picture by pressing the CHANNEL buttons (▲/▼).
- If the picture is distorted or rolling vertically, adjust the vertical hold control on your TV, if so equipped. You can watch in the slow motion by pressing the SLOW button during playback or the still mode.
- If a noise bar appears on the TV screen, you can reduce it by pressing the CHANNEL buttons (▲/▼).
- After the DVD/VCR has been in Still/Slow mode for 5 minutes, it will stop automatically to protect the tape and the video head from damage.
- To return to playback, press the PLAY button.

AUTO REPEAT PLAYBACK

VCR

This feature allows you to play a tape over and over.

- 1 Select main menu by pressing the MENU button.

- 2 Select "AUTO REPEAT" by pressing the PLAY or the STOP button.

- 3 Begin auto repeat playback by pressing the F.FWD button so that [ON] appears next to "AUTO REPEAT".

- If the on-screen menu still remains, press the CLEAR/C.RESET button to exit the menu.
- To cancel the Auto repeat mode, press the F.FWD button at step [3] so that [OFF] appears next to "AUTO REPEAT".

SEARCH FUNCTIONS

VCR

PICTURE SEARCH

If you want to skip or repeat a scene during playback, press the F.FWD or the REW button.

- Press it again and the DVD/VCR will now search at super high speed. (in the LP/SLP modes only).

INDEX SEARCH

The index signal is recorded on the tape automatically when the recording is started. If you want to view a recording at a specific start point, this can be done easily.

- 1 Press the SEARCH MODE button so that the Index Search menu appears.

- 2 Enter your desired number by pressing the PLAY or the STOP button within 30 seconds.

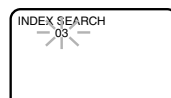

- 3 Press the F.FWD or the REW button to start index search.

- If you want to go in the forward direction, press the F.FWD button. If you want to go in the reverse direction, press the REW button.
- After index search, the DVD/VCR will play the tape automatically.

TIME SEARCH

This feature allows you to fast forward or rewind the tape for the desired length of time.

- 1 Press the SEARCH MODE button twice so that the Time Search menu appears.

- 2 Enter your desired time to skip by pressing the PLAY or the STOP button within 30 seconds.

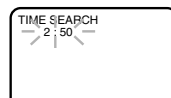

- 3 Press the F.FWD or the REW button to start time search.

- If you want to go in the forward direction, press the F.FWD button.
- If you want to go in the reverse direction, press the REW button.
- After time search, the DVD/VCR will play the tape automatically.

RECORDING FUNCTION

VCR VCR

It may be UNLAWFUL to record copyrighted material without the consent of the copyright owner.

Accidental Erasure Prevention

To prevent accidental recording on a recorded cassette, remove its record safety tab. To record on it later, cover the hole with cellophane tape.



Before recording, make sure:

- The desired channel is selected by pressing the Number buttons on the remote control or the CHANNEL buttons (▲/▼). (If you connected the DVD/VCR to a cable box or satellite box as in "DVD/VCR TO TV CONNECTION" on page 14, set the DVD/VCR to channel 3 or 4 i.e. the same channel as the CH3 or CH4 switch on the back of the DVD/VCR. Then, select the channel you want to record with the cable box or satellite box. In this case, you can ONLY record and view the SAME channel.)
- There is a tape with a safety tab into the DVD/VCR.
- The desired recording speed is selected in SP (standard play) or SLP (super long play) mode by pressing the SPEED button on the remote control.

Tape Speed	Recording/Playback Time			
	Type of tape	T60	T120	T160
SP mode		1 hour	2 hours	2-2/3 hours
SLP mode		3 hours	6 hours	8 hours

- TV STEREO or SAP is selected.

VIEWING AND RECORDING THE SAME PROGRAM

VCR

1 Begin the recording by pressing the RECORD button. The REC/OTR Light comes on.

- To temporarily stop recording or to resume it, press the PAUSE button. After the DVD/VCR has been in Pause mode for 5 minutes, it will stop automatically to protect the tape and the video head from damage.

2 Press the STOP button when the recording is completed.

- If a tape ends during recording, the VCR will automatically stop, rewind, and eject the tape.

OTR (One Touch Recording)

VCR

This feature allows you to set the recording length simply by pressing the REC/OTR button on the DVD/VCR.

3 Press the REC/OTR button to begin OTR. The REC/OTR Light comes on. Change the recording length by pressing the REC/OTR button repeatedly.

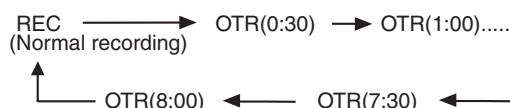

- If a tape ends during OTR, the VCR will stop, eject the tape, and switch to the DVD mode automatically as the TIMER SET light blinks. (If the DVD power is off, the DVD/VCR will become STANDBY status).
- When OTR is finished, the VCR turns off automatically. To use the VCR again, press the TIMER SET button on the DVD/VCR.

TIMER RECORDING

VCR

You may set the DVD/VCR to start recording while you are away. You can set seven programs to record on specific days, daily or weekly within a 1 year period.

If you have not yet set the clock, "CLOCK SET" appears. If so, follow the steps [3] and [4] in "CLOCK SET" section on page 18. Then, set the timer recording.

- 1** Insert a tape with its safety tab intact.
- 2** Press the MENU button.
- 3** Select "TIMER PROGRAMMING" by pressing the PLAY or the STOP button. Then, press the F.FWD button. The set up screen is displayed.

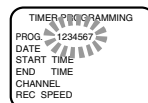

4 Set the timer.

- If you make mistakes, press the REW button repeatedly to go back to the item you want to correct.
- If you press the REW button after step 7), all the information you've just entered for that program number will be cleared.

1) Set the program number (1-7)

A program number which is not allocated flashes. Press the PLAY button or the STOP button repeatedly for the desired program number. Then, press the F.FWD button.

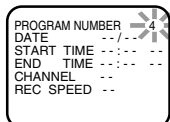

2) Set the frequency of the recording

Press the PLAY button or the STOP button to select the desired frequency from ONCE, DAILY, or WEEKLY recording. Then, press the F.FWD button.

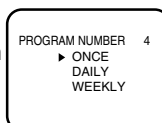

3) Set the date

First, press the PLAY button or the STOP button for the month. Then, press the F.FWD button. Next, press the PLAY button or the STOP button for the day. Then, press the F.FWD button.

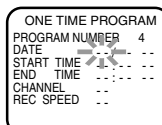

4) Set the start time

First, press the PLAY button or the STOP button for the hour. Then, press the F.FWD button. Next, press the PLAY button or the STOP button for the minute. Then, press the F.FWD button. And then, press the PLAY button or the STOP button for AM or PM. Then, press the F.FWD button.

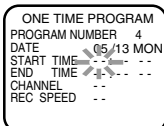

5) Set the end time

Follow the same instructions as "Set the start time" to set the end time.

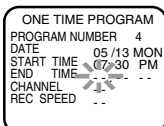

6) Set the channel number

Press the PLAY button or the STOP button repeatedly for the desired channel number. Then, press the F.FWD button.

If you connected the DVD/VCR to a cable box or satellite box as in "DVD/VCR TO TV CONNECTION" on page 14, set the DVD/VCR to channel 3 or 4 i.e. the same channel as the CH3 or CH4 switch on the back of the DVD/VCR. Then, select the channel you want to record with the cable box or satellite box. Leave the cable box or satellite box on for timer recording.

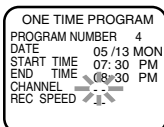

7) Set the tape speed

Press the PLAY button or the STOP button repeatedly for the desired tape speed. Then, press the F.FWD button.

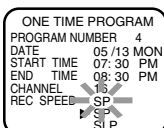

5 To set another program, repeat step [4]. To exit from the set up screen, press the CLEAR/C.RESET button (You only exit from the set up screen. the information you entered for the timer recording will not be cleared).

6 When you finish programming, press the TIMER SET button to activate the timer.

- As the TIMER SET light comes on the VCR becomes STANDBY status, and switches to DVD OUTPUT mode automatically.
- When DVD sits idle for more than thirty-five minutes, the DVD power will be turned off automatically. If you press the TIMER SET button under such condition, the DVD/VCR power will be turned off and become STANDBY status.

TO CLEAR A PROGRAM

Follow the steps from 2 to 3. Select the program number you want to clear, and then press the REW button.

HINTS FOR TIMER RECORDING

VCR

- If there is a power failure or the DVD/VCR is unplugged for more than 30 seconds, the clock setting and all timer settings will be lost.
- If a tape ends during TIMER RECORDING, the VCR will stop, eject the tape, and switch to the DVD mode automatically as the TIMER SET light blinks. (If the DVD power is off, the DVD/VCR will become STANDBY status).

- If a tape is not in the DVD/VCR or does not have a safety tab, the TIMER SET light flashes and timer recording will not operate. Please insert a recordable tape.
- When all timer recordings are finished, the TIMER SET light will flash. To use the DVD/VCR again as usual, press the TIMER SET button to disable the flashing TIMER SET light, then press the VCR/TV button to select the VCR position. The VCR/TV light will appear. Press the VCR button to choose VCR or DVD mode, then continue with the other features as described in this manual.
- When timer recordings are set, the TIMER SET light will come on. To use the DVD/VCR as usual until the time for the recording, press the TIMER SET button so that the TIMER SET light disappears. Press the VCR/TV button to choose the VCR position. The VCR/TV light will come on. Press the VCR button to choose VCR or DVD modes, then continue with the other features as described in this manual.

If you want to use the DVD player during a VCR timer recording or while the TIMER SET light is on or flashes.

- You can use the DVD player while the TIMER SET light is on or flashes, or during a timer recording. Press the POWER button to turn on the DVD/VCR. Press the VCR/TV button to choose VCR position. Press the DVD button on the remote control to choose DVD mode, then continue with the other DVD features as described in this manual. You don't have to set the TIMER off to use the DVD.

TO STOP AN AUTOMATIC TIMER PROGRAM ALREADY STARTED

Press the STOP/EJECT or the TIMER SET button on the DVD/VCR.

TO CHECK, CORRECT, OR CANCEL AN AUTOMATIC TIMER PROGRAM

- 1 Turn the power on by pressing the POWER button. (If the DVD/VCR is in TIMER STANDBY status, press the TIMER SET button instead of the POWER button.)
- 2 Select main menu by pressing the MENU button.
- 3 Select "TIMER PROGRAMMING" by pressing the PLAY or the STOP button. Then, press the F.FWD button.
- 4 Select the program number which you want to check by pressing the PLAY or the STOP button.

- The details of the selected program appears on the TV screen.
- Go to the digit you want to change by pressing the F.FWD or the REW button. Then, enter correct numbers by pressing the PLAY or the STOP button.
- You may cancel the entire program by pressing the REW button while the program number flashes.

5 Press the CLEAR/C.RESET button to exit.

6 Press the TIMER SET button to return to timer stand-by mode.

SPECIAL FEATURES

COPYING A VIDEO TAPE

VCR

You can make copies of video tapes made by friends or relatives for your enjoyment.

Warning:

Unauthorized recordings of copyrighted video tapes may be an infringement of copyright laws.

Connect the recording DVD/VCR (this unit), the playing VCR (another source) and your TV using the following diagram.

- You can use the AUDIO/VIDEO input jacks on the front panel of the DVD/VCR instead of using the jacks on the back.

[Recording VCR]
(this unit)

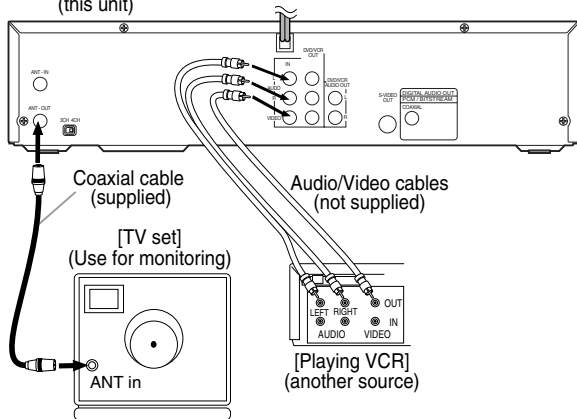

1 Insert a pre-recorded tape into the playing VCR.

2 Insert a tape with a safety tab into the recording VCR.

3 Press the SPEED button on the recording VCR to select the desired recording speed (SP/SLP).

- When you use the A/V input jacks on the back of the DVD/VCR, select "L1" position by pressing [0], [0], [1] on the remote control or the CHANNEL buttons (▲/▼).
- When you use the A/V input jacks on the front of the DVD/VCR, select "L2" position by pressing [0], [0], [2] on the remote control or the CHANNEL buttons (▲/▼).

Note

"L1" and "L2" are found before the lowest memorized channel. (Example: CH2)

4 Press the REC/OTR button on the recording VCR.

5 Begin playback of the tape in the playing VCR.

- For best results during dubbing, use the DVD/VCR's front panel controls whenever possible. The remote control might affect the playing DVD/VCR's operation.

- Always use video-quality shielded cables with RCA-type connectors. Standard audio cables are not recommended.
- You can use a video disc player, satellite receiver, or other audio/video component with A/V outputs in place of the playing VCR.

TO MONITOR THE RECORDING

1 Turn on the TV and set the TV to channel 3 or 4.

- Now set the CH3/CH4 switch on the back of the DVD/VCR to match the channel selected on the TV.

2 Press the VCR/TV button on the recording VCR so that the VCR/TV Light comes on.

MTS (Multi-Channel Television Sound) SYSTEM

VCR

When you play a VHS tape, or receive a broadcast on the DVD/VCR tuner channel you are watching, the current status will appear when you press the DISPLAY button on the remote control. When you record a MTS broadcast signal, you need to set it to MTS mode.

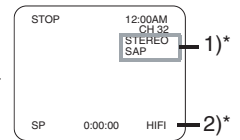

1)* When a program is broadcast in stereo, STEREO appears. When a program is broadcast in second audio, SAP appears.

- Although a program may be broadcast in both stereo and sub audio, you must select the Recording mode to TV STEREO or SAP before you record a broadcast.

2)* While the VCR is set in HiFi stereo mode, HiFi appears on the TV screen. While the VCR is set in monaural (MONO) mode, HiFi disappears from the TV screen.

- If you play non-HiFi tapes while the VCR is set in HiFi, HiFi will disappear from the TV screen and the VCR will automatically play in monaural.

MTS RECORDING/MONITOR MODE

Type of broadcast	Display on the TV screen	STEREO/SAP Selection	Hi-Fi audio track (2-channel)		Normal audio track
			L-channel	R-channel	
Regular (monaural audio)	-None-	-Invalid-	Mono	Mono	Mono
Stereo broadcast	STEREO	-Invalid-	L	R	L+R
Bilingual broadcast	SAP	TV STEREO*	Main audio program	Main audio program	Main audio program
		SAP*	Sub audio program	Sub audio program	Sub audio program
Stereo & Bilingual broadcast	STEREO SAP	TV STEREO*	L	R	L+R
		SAP*	Sub audio program	Sub audio program	Sub audio program

* You must select the recording mode to TV STEREO or SAP before you record a broadcast.

AUTO REWIND

When a tape reaches the end during recording, playback, or fast-forward, the tape will automatically rewind to the beginning. After rewinding finishes, the DVD/VCR will eject the tape and switch itself off.

- The DVD/VCR will not rewind the tape automatically during timer recording or One Touch Recording.

REAL TIME TAPE COUNTER

- This shows the elapsed recording or playback time in hours, minutes, and seconds. (The displayed time will not change during blank portions of the tape.)
- The indication will appear when the tape is rewound further than “0:00:00” on the tape counter.

PLAYING A DISC

PLAYING A DVD VIDEO OR AN AUDIO CD

DVD

CD

Getting started

Turn on the power of the TV, amplifier and any other components which are connected to the DVD/VCR. (Change the input system to suite the DVD/VCR, and check that the sound volume is correct).

1 Press the POWER button.

- The power will turn on.

Check that the DVD OUTPUT Light is lit. If not press the DVD button on the remote control to switch to DVD/VCR mode.

2 Press the OPEN/CLOSE button.

- The disc loading tray will open.

3 Place a disc into the tray.

- Make sure the disc is sitting properly in the correct recess, with the label side up.

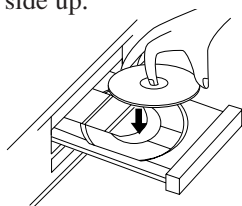

4 Press the PLAY button.

- The tray will close automatically, and playback will then start from the first chapter or track of the disc. You need to press the PLAY button only when the tray has been closed by pressing the OPEN/CLOSE button.
- If your DVD has a title menu, it may appear on the screen. In this case, refer to “USING THE DVD MENUS” in the next section, or “USING THE TITLE MENU” on page 24.

5 Press the STOP button to stop play.

Notes

- A “prohibited icon” may appear at the top-right on the TV screen during operation, warning that a prohibited operation has been encountered by the DVD/VCR or the disc.
- If a disc is dirty or has scratches, the pictures may appear distorted and the playback operation may stop. In such cases, clean the disc and unplug the power cord and then plug it again before resuming playback.
- With DVDs that use titles for playback program signals, playback may start from the second title, or it may skip these titles.
- During the playback of a two layered disc, pictures may stop for a moment. This happens when the 1st layer switches to the 2nd layer. This is not a malfunction.



USING THE DVD MENUS

DVD

Some DVDs contain their own menus, such as a guidance menu which describes the contents of the disc or a selection menu for sound, language and other customized settings.

1 Press the MENU button.

- The DVD menu will appear.

2 Select the desired title.

- Press the Arrow buttons (▼/▲/▶/◀) to change the setting, and then press the ENTER button.

3 Playback will start from the selected title.

USING THE TITLE MENU

DVD

With a DVD containing a title menu, you can select the desired titles from the menu.

1 Press the TITLE button.

- The title menu will appear.
- With some discs, a title menu may appear automatically. In this case, skip to step 2.

2 Select the desired title.

- Press the Arrow buttons (▼/▲/▶/◀) to select a desired title, and then press the ENTER button.

CALLING UP A MENU SCREEN DURING PLAYBACK

For DVDs

- Press the MENU button to call up the DVD menu.
- Press the TITLE button to call up the title menu.

Note

- The contents of menus and corresponding menu operations may vary between discs. Refer to the manual accompanying the disc for details.

PAUSING PLAYBACK OR DISPLAYING A STILL PICTURE

DVD

CD

1 Press the PAUSE button during playback.

- Playback will pause, with sound muted.



2 Press the PLAY button to resume playback.



RESUMING PLAYBACK FROM THE POINT WHERE PLAYBACK STOPPED

DVD

CD

1 Press the STOP button during playback.

- Playback will stop, and then appear the resuming message at the center.

Press 'PLAY' to play from here.
To play the beginning, press 'STOP' first
and then 'PLAY'.

- ### 2 Press the PLAY button. Playback will start from the point where the previous playback session was stopped.



Note

- The resume function can be reset by pressing the STOP button twice or by opening the disc loading tray.

STEPPING THROUGH FRAMES

DVD

- ### 1 Press the PAUSE button while playback is paused.

- The next picture frame is displayed with sound muted each time the button is pressed.



- ### 2 Press the PLAY button to resume playback.



FAST FORWARD/REVERSE

DVD

CD

1 Press the FWD ►► or the REV ◀◀ button during playback.

- For DVDs, pressing the FWD ►► or REV ◀◀ button cycles the playback speed in four steps. In the case of DVDs, the sound will mute.
- For audio CDs, the playback speed is fixed at $\times 16$.

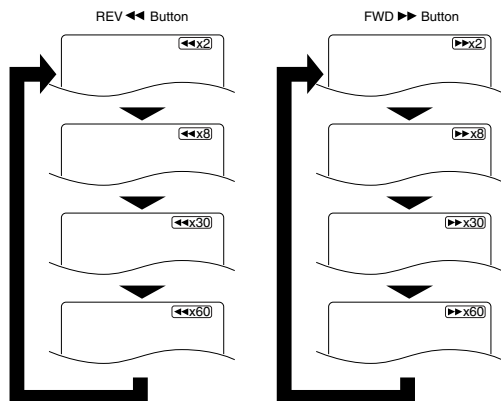

2 Press the PLAY button to return to normal playback speed.

SLOW MOTION

DVD

1 Press the FWD ►► button while playback is paused. (Sound remains muted.)

- Slow motion mode will be activated.
- Pressing the FWD ►► button cycles the playback speed in three steps. Select the appropriate speed while referring to the speed indication on the screen.

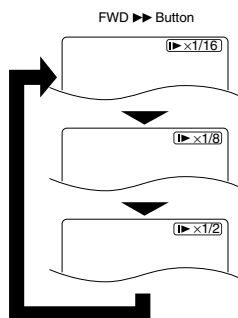

2 Press the PLAY button to return to normal playback speed.

Notes

- Slow playback is not available with audio CDs.
- Reverse slow motion is not available.
- Slow playback from a TITLE to other TITLE is not possible.

STARTING FROM A DESIRED TRACK

CD

1 Press the Number buttons to enter the desired track number.

- The selected track will be located, and playback will start.

You can also press the SEARCH MODE button and use the Number buttons to enter the track number.



When the track number is entered in the entry box, playback of the desired track will start automatically.

TRICKS WITH THE SKIP BUTTONS (◀◀, ►►)

If the SKIP button ►► is pressed during playback or while playback is paused, the current track will be skipped and the next track will start. If the SKIP button ◀◀ is pressed once, the beginning of the current track will be located for replay. If the SKIP button ◀◀ is pressed again within 2 seconds after playback begins, the previous track will be located.

PLAYING FROM A DESIRED TITLE OR A CHAPTER

DVD

There are two ways you can jump to a desired title or a chapter.

By using the 'SEARCH MODE' button.

1 Press the 'SEARCH MODE' button.

- The title/chapter search display will be displayed.



2 If you wish to perform a title search, select 'TT'. If you wish to perform a chapter search, select 'CH' with the Arrow buttons (▲/▼).

3 Enter the desired title or chapter number with the Number buttons (If you are entering a single digit number press "0" first).

- When you finish entering the number, the selected title or chapter will start automatically.

Notes

- If you didn't press "0" before entering the single digit number, you have to press ENTER to go to the desired title or the chapter.

By using only the
TITLE SEARCH:

- 1 Directly enter the desired title number with the Number buttons with playback stopped.

CHAPTER SEARCH:

- 1 Directly enter the desired chapter number with the Number buttons when the disc is being played or paused.
- When you finish entering the number, the selected title or chapter will start automatically.

Notes

- Play back from a desired title or chapter is not available with some DVDs.
- If the title being played does not display the chapter number, that means the chapter search function is not available with that title.

TRICKS WITH THE SKIP BUTTONS (◀◀, ▶▶)

If the SKIP button ▶▶ is pressed during playback or while playback is paused, the current chapter will be skipped and the next chapter will start. If the SKIP button ◀◀ is pressed once, the beginning of the current chapter will be located for replay. If the SKIP button ◀◀ is pressed again within 2 seconds after playback begins, the previous chapter will be located.

STARTING FROM A DESIRED TIME COUNT

DVD CD

- 1 Press the SEARCH MODE button twice during playback or while paused.

- 2 Press the Number buttons to set the desired time count.

- **Example:** 1 hour, 23 minutes and 30 seconds
1 → 2 → 3 → 3 → 0

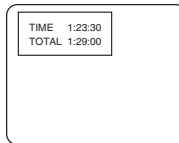

Notes

- For a DVD, Time Search in Title is effective. (But Time Search in Chapter is ineffective.)
- For a CD, Time Search in Track is effective. (But Time Search in the entire disc is ineffective.)
- Playback from a desired time count is not available with some discs or if the unit is in stop mode.
- If the wrong numbers are entered, press the CLEAR/C.RESET button and re-enter the correct numbers.

MARKER

DVD CD

You can define the part to be called back.

- 1 Press the SEARCH MODE button three times during playback.

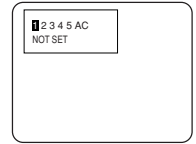

Set the marker

- Using the Arrow buttons (◀/▶), position the cursor on to the marker number shown as “NOT SET”. Press the ENTER button when the screen to be reviewed appears. The marked time will be displayed. Up to 5 points can be marked.

Call back the marker

- Using the Arrow buttons (◀/▶), position the cursor on to the marker number to be called back and press the ENTER button.

Clear the marker

- Using the Arrow buttons (◀/▶), position the cursor on to the marker number to be cleared and press the CLEAR/C.RESET button.
- To clear all markers, place the cursor on “AC” (All clear markers) and press the ENTER button.

- 2 Press the SEARCH MODE button or the RETURN button to exit the display.

RANDOM (Audio CD)

CD

- 1 Press the MODE button in stop mode.

- The program setting menu screen will appear.

- 2 Press the MODE button again.

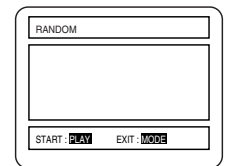

- 3 Press the PLAY button. Random playback will then start.

Note

- Program playback is not available during random playback.

REPEAT

DVD CD

1 Press the REPEAT button during playback.

For DVDs

- A single title or chapter can be played back repeatedly.
- Pressing the REPEAT button cycles the display on the screen as follows.

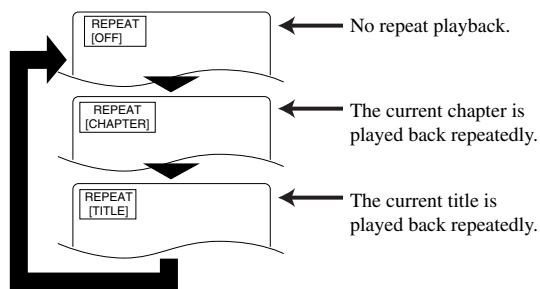

For audio CDs

- The whole disc or a single track can be played back repeatedly.
- Pressing the REPEAT button cycles the display on the screen through **Off**, **Track** and **All**.

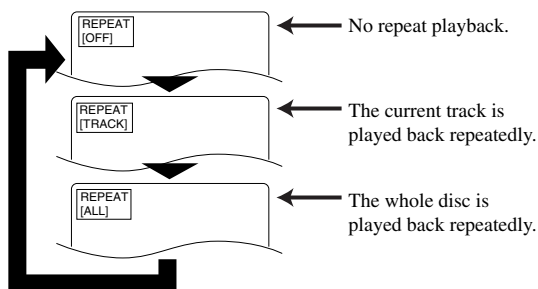

If the REPEAT button is pressed once during program/random playback, the current track will be played back repeatedly.

If the REPEAT button is pressed again, the program/random playback will be performed repeatedly.

Notes

- Repeat playback is not available with some discs.
- The REPEAT setting will be cleared when moving to an other title, chapter or track.
- Repeat playback does not function during A-B repeat playback.

A-B REPEAT

DVD CD

You can define a section to be played back repeatedly.

1 Press the A-B REPEAT button during playback.

- The starting point (A) will then be selected.

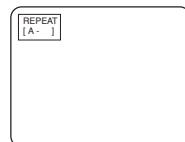

2 Press the A-B REPEAT button again at the end point (B) of the desired section.

- The selected section will be played back repeatedly.

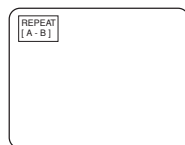

3 To exit A-B repeat playback, press the A-B REPEAT button and set it to OFF.

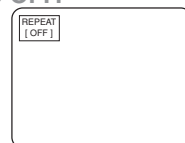

Notes

- With DVDs, the A-B repeat section can be set only within the current title.
- With audio CDs, the A-B repeat section can be set within the current track.
- A-B repeat is not available with some scenes in DVD.
- To cancel the A point which was set, press the CLEAR/C.RESET button.
- A-B repeat playback does not function when title, chapter, or repeat (all) playback has been set.

PROGRAM (Audio CD)

CD

1 Press the MODE button in stop mode.

- The program screen will appear.

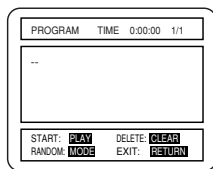

2 Press the Number buttons to enter the desired track numbers.

- 50 programs can be displayed at once on the screen. Press “▼” to go to the next page.

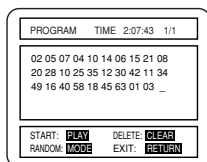

3 Press the PLAY button.

- Playback will start in the programmed order.
- While the program is being played back, the STOP button works as follows.
- Press the STOP button once and then press the PLAY button again. Playback will restart from the point where the STOP button was pressed. (Program continued)

TO CLEAR THE PROGRAM

1 Press the STOP button twice, and the program will be cleared.

Notes

- Adding programs is not possible during program playback. You must stop the current playback before such operations can be carried out.
- Press the CLEAR/C.RESET button to cancel a program. The most recently entered program will then be deleted.
- Up to 99 programs can be entered.
- Playback from a desired track and random playback are not available during program playback.
- Program settings will be cleared when the power is turned off or the disc loading tray is opened.
- Press the MODE button to check the programmed setting.
- The programs will be cleared when you turn the power off.

ZOOM PLAYBACK (enlargement on-screen)

DVD

Images can be enlarged on the screen to your taste.

1 Press the ZOOM button during playback.

- The image will be enlarged at the center of the screen.
- Pressing the ZOOM button cycles the zooming images in two steps.



2 When the Arrow button (▲/▼/◀/▶) is pressed during zoom play, the part to be zoomed moves.

- The zooming frame can be moved from the center 4 steps to the right, 4 steps to the left, 4 steps to the top, and 4 steps to the bottom when times 2 zooming. The frames will move 6 steps when times 4 zooming.
- The current position will be displayed on the right-bottom of the screen. Press the ENTER button, and the display will disappear.

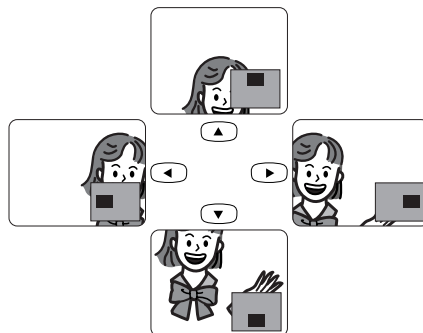

Note

- Zooming function does not work while the disc menu is being shown.

PLAYING AN MP3 DISC

MP3

1 Insert an MP3 file recorded on disc.

- The MP3 menu screen is displayed.
- Folders are referred to as “Albums” and files are referred to as “Tracks”.
- “+” appears at the beginning of the album name.



- If all the tracks cannot be displayed at once on the screen, “▼” appears to go to the next page. If there is a previous page, “▲” appears on screen. To the left of “▼”, the current page and the total number of pages are displayed.
- The player can recognize 255 albums and tracks altogether.

2 Using the Arrow buttons (▲/▼), select a album or a track to be played.

[When a TRACK is selected]

Starting from the selected track, the rest of the tracks will be played in order.

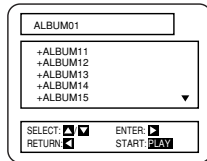

[When an ALBUM is selected]

Press the Arrow button (▶). The track selection screen shows up. Using the Arrow buttons (▲/▼), select the tracks to be played.

- Choose “FIRST PLAY”, and the albums and tracks will be played from the beginning of the disc.
- Press the TITLE button, and the top hierarchy will be called back.
- Albums can be played up to the 8th hierarchy.

3 Press the PLAY button.

- Playback will start.

4 To stop playing, press the STOP button.

CHANGING THE ON-SCREEN DISPLAY DURING MP3 DISC PLAY

MP3

The information on an MP3 disc in play can be checked.

1 Press the DISPLAY button during playback.

- The track currently being played will be highlighted.

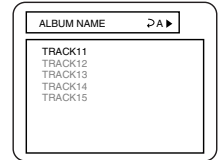

2 Press the DISPLAY button again.

- The album name being displayed will be replaced by the elapsed time of the track.
- will be displayed when repeat play has been selected.

- T: Track repeat
- A: Album (folder) repeat
- D: Disc repeat

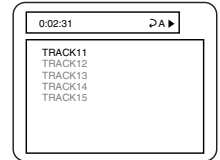

3 Press the DISPLAY button again, and the display screen disappears.

PLAYING A DESIRED TRACK FROM AN MP3 DISC

MP3

1 Press the **SEARCH MODE** button during playback.

- The **SEARCH** menu is displayed.
- The track currently being played or in **RESUME ON** will be highlighted. In the case of **RESUME OFF**, the first track of the disc will be highlighted.
- Press the **RETURN** button, and the **SEARCH** menu disappears.

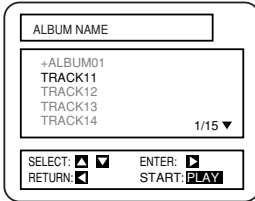

2 Using the **Arrow** buttons (**▲/▼**), select the track to be played. Then press the **PLAY** button to start playing.

Notes

- During play, a desired track can be searched for directly. Just enter the track number with the **Number** buttons.
- If the track number entered is not available, the “disable” symbol appears and the direct search mode is cancelled.
- Playback cannot be started from a desired time count.

PLAYING AN MP3 DISC RANDOMLY

MP3

1 Press the **MODE** button twice in **STOP** mode.

- The random setting menu screen will appear.

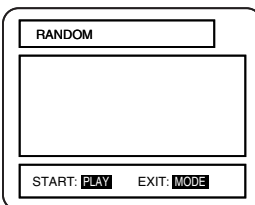

2 Press the **PLAY** button.

- Random play will begin.

PLAYING AN MP3 DISC IN A PROGRAM

MP3

1 Press the **MODE** button in **STOP** mode.

- The program screen is displayed.

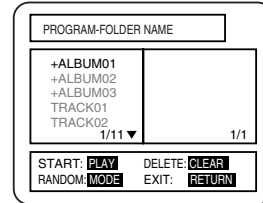

2 Use the **Arrow** buttons (**▼/▲**) to select a track. Then press the **ENTER** button to save it in a program.

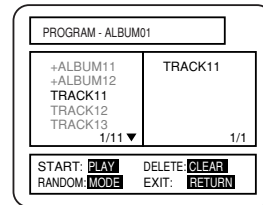

- When an album name is highlighted, press the **Arrow** button (**▼**), and the next hierarchy is displayed.
- Press the **Arrow** button (**▲**) to go back to the previous hierarchy.
- If the entire program cannot be displayed at once on the screen, “▼” appears to go to the next page.

3 When the program has been selected, press the **PLAY** button.

- The program will begin.

Notes

- Press the **CLEAR/C.RESET** button, and the last-programmed entry will be deleted.
- Press the **RETURN** button, and the program screen will be displayed and the program stored in memory.
- The program setting will be cancelled when the power is turned off or the disc tray is opened.

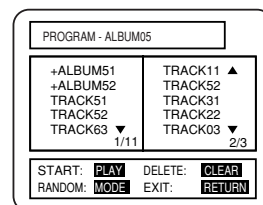

SETTINGS

CHANGING THE AUDIO LANGUAGE OR SOUND MODE

DVD

CD

The DVD/VCR has a function which allows you to select the desired audio language and sound mode.

For DVDs

1 Press the AUDIO button during playback.

- The current audio status will appear at the top.

2 Press the AUDIO button repeatedly until you see the language of your choice.

- The audio language mode can be changed only if the disc is recorded with a multiple language setting.

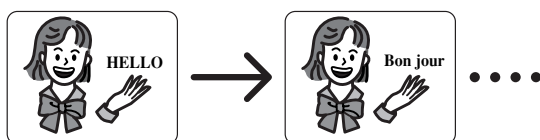
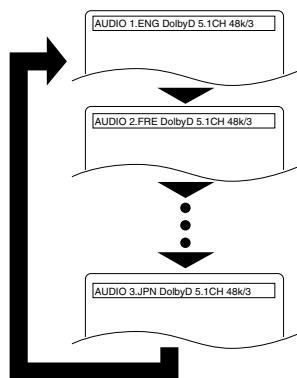

Notes

- Pressing the Audio button may not work on some DVDs with multiple audio languages (e.g. DVDs which allow audio language setting on the disc menu). Operation varies between discs, so refer to the manual accompanying the disc.
- The current audio language and sound mode will be displayed when you first press the AUDIO button.
- If the desired language is not shown after pressing the Audio button several times, the disc does not have an audio source in that language.
- The audio language resets to the one which was selected in the setup mode every time the power is turned on or discs are replaced. If that language is not available on a disc, a language defined by the disc will be selected.
- The screen display will disappear after about 5 seconds.

For audio CDs

Press the AUDIO button during playback.

- Pressing the AUDIO button cycles the sound mode through STEREO, L-CH and R-CH.

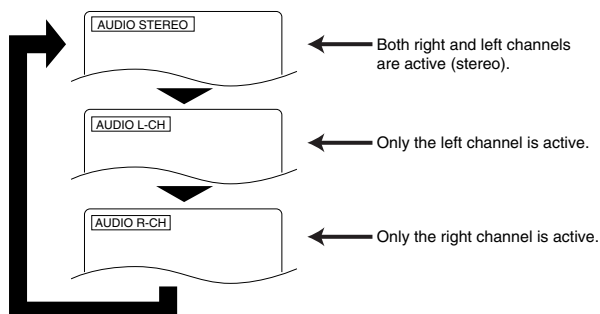

CHANGING THE SUBTITLE LANGUAGE

DVD

The DVD/VCR has a function which allows you to select the desired language for subtitles.

- 1 Press the **SUBTITLE** button during playback, and then press the **SUBTITLE** button to select the desired subtitle language.

- The subtitle language can be changed if the subtitles are recorded in multiple languages on the DVD being played.
- The subtitle language cannot be changed if the subtitles are recorded in a single language on the DVD being played.

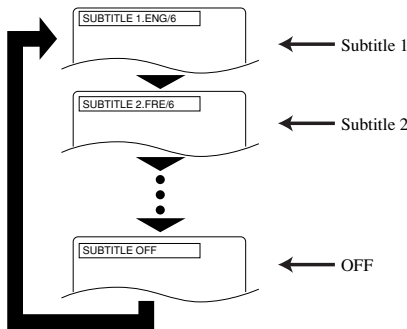

- Pressing the **SUBTITLE** button cycles the subtitle language from **SUBTITLE 1**, **SUBTITLE 2** and all the languages recorded.
- The current subtitle mode will be displayed when you first press the **SUBTITLE** button.
- Press the **SUBTITLE** button, and then press the Arrow buttons (◀/▶) to set it to on or off.

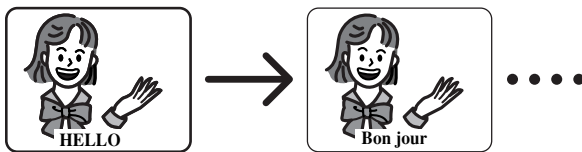

Notes

- Some discs allow subtitle language setting on the disc menu. (Operation varies between discs, so refer to the manual accompanying the disc.)
- If the desired language is not shown after pressing the **SUBTITLE** button several times, the disc does not have subtitles in that language.
- The subtitle language resets to the one which was selected in the setup mode, every time the power is turned on or discs are replaced. If that language is not available on a disc, a language defined by the disc is selected.

- It may take time to display the subtitles in the selected language.
- The screen display will disappear after about 5 seconds.
- When “SUBTITLE NOT AVAILABLE” appears on screen, it means that no subtitle has been recorded.

CHANGING THE CAMERA ANGLE (Multi-Angle Pictures)

DVD

The DVD/VCR has a function which allows you to select the desired camera angle.

- 1 Press the **ANGLE** button during playback.

- If the disc contains sequences recorded from different camera angles, the angle icon (📷) will appear at the top-right of the screen. You can change the camera angle when the icon appears on the screen.
- The camera angle cannot be changed if the disc does not contain sequences recorded from different camera angles.

- 2 Press the **ANGLE** button while the angle number is shown on the screen.

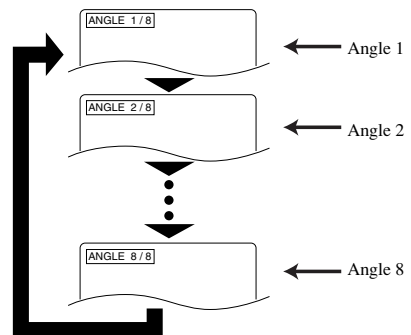

Notes

- The screen display will disappear after about 5 seconds.
- The current camera angle will be displayed when you first press the **ANGLE** button.

CHANGING THE ON-SCREEN DISPLAY

DVD

CD

You can check the information regarding the disc by pressing the DISPLAY button on the remote control.

For DVDs

1 Press the DISPLAY button during playback.

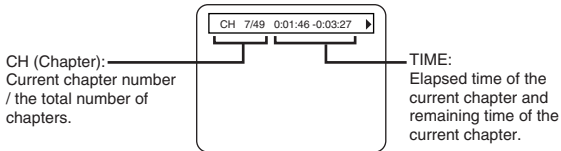

2 Press the DISPLAY button again.

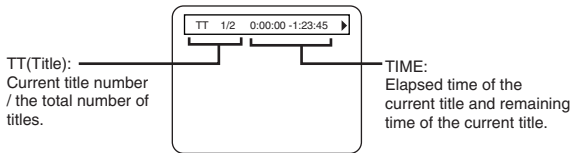

• Use the Number button to start from the desired chapter.

3 Press the DISPLAY button again.

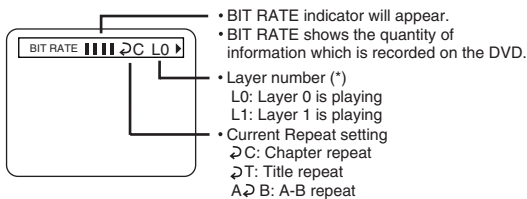

* appears when a layered disc is playing.

4 Press the DISPLAY button or the RETURN button to exit the display.

For audio CDs

1 Press the DISPLAY button during playback.

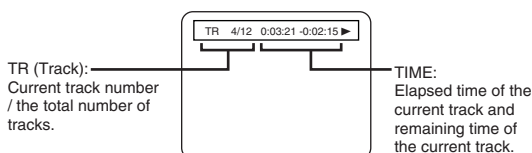

2 Press the DISPLAY button again.

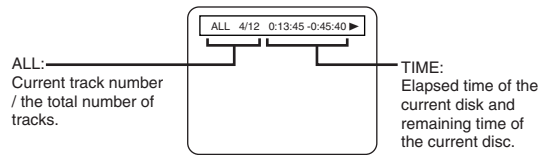

• Use the Number buttons to start from a desired track.

3 Press the DISPLAY button or the RETURN button to exit the display.

BLACK LEVEL SETTINGS

DVD

You can select the BLACK LEVEL ON to make the black areas of the picture brighter.

1 Press the MODE button during playback.

• The setup screen is displayed.

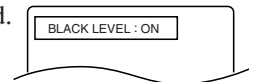

2 Press the ENTER button to turn it on or off.

• ON: This makes the dark parts brighter. (Default: ON)

OFF: The original picture which is recorded on the disc will be shown.

• Press the RETURN button to exit the display.

CHANGING THE SETUP ITEMS

LANGUAGE SETTINGS

DVD

1 Press the **SETUP** button in **STOP** mode.

- The setup screen is displayed.

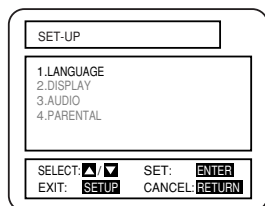

2 Press the Arrow buttons (**▲/▼**) to select **Language**, and then press the **ENTER** button.

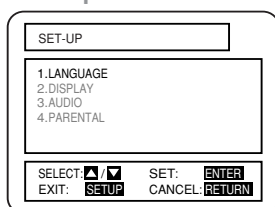

3 Press the Arrow buttons (**▲/▼**) to select an item, and then press the **ENTER** button.

AUDIO:

(Voice is played in selected language.)

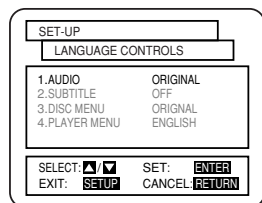

SUBTITLE:

(Subtitles are shown in selected language.)

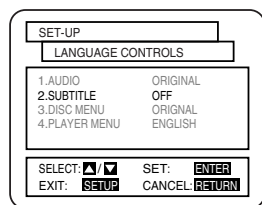

DISC MENU:

(The disc menu appears in selected language.)

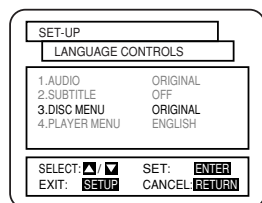

PLAYER MENU:

(The on-screen display appears in selected language.)

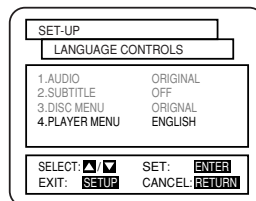

4 Press the Arrow buttons (**▲/▼**) to select a desired item, and then press the **ENTER** button.

- If “OTHER” is selected on the **AUDIO**, **SUBTITLE** or **DISC MENU** setting screen, the Language Code setting screen will appear. Press the Number buttons to enter the desired language code while referring to the list on page 38.

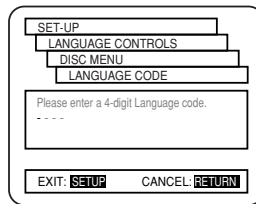

5 Press the **SETUP** button.

- The setup mode will be canceled and the ordinary screen is displayed.

Notes

- Language Setting for Audio and Subtitle is not available with some discs, so use the Audio and the Subtitle button. Details are on pages 31 and 32.
- You can also select an item by entering the number besides it using the Number buttons.
- When you change the setup items, press the **STOP** button if you are in playback mode.
- While the setup menu is shown, you can not open or close the tray.

DISPLAY SETTINGS

DVD

1 Press the **SETUP** button in **STOP** mode.

- The setup screen will appear.

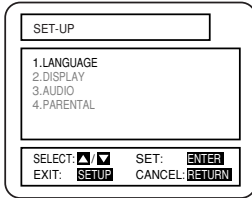

2 Press the Arrow buttons (**▲/▼**) to select **DISPLAY** and then press the **ENTER** button.

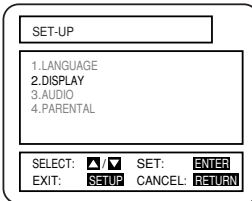

3 Press the Arrow buttons (**▲/▼**) to select an item, and then press the **ENTER** button.

TV ASPECT (Default: 4:3 LETTER BOX)
4:3 LETTER BOX: Wide screen with black bars on top and bottom
4:3 PAN & SCAN: Full height picture, trimmed both sides
16:9 WIDE: If wide screen TV is connected

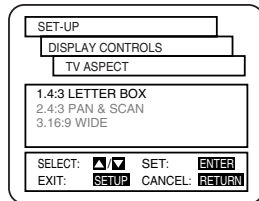
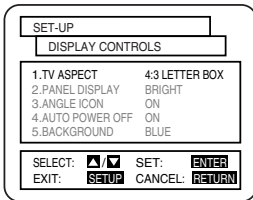

ANGLE ICON (Default: ON)
 Display or not display the Angle icon on the screen.

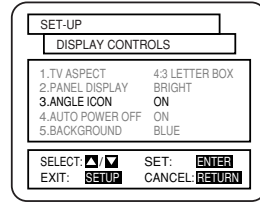

AUTO POWER OFF (Default: ON)
 Set or not set to turn off after the screen saver is started and no keys are pressed for 35 minutes.

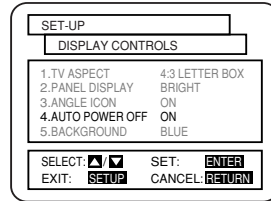

BACKGROUND COLOR (Default: BLUE)
 Select blue or gray.

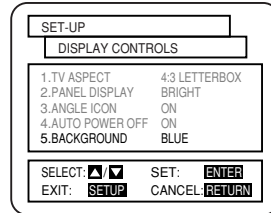

4 Press the Arrow buttons (**▲/▼**) to select a desired item, and then press the **ENTER** button to change the setting.

5 Press the **SETUP** button.

- The setup mode will be canceled and the ordinary screen will appear.

Notes

- You can also select an item by entering the number besides it using the Number buttons.

PANEL DISPLAY (Default : BRIGHT)
 Adjust the brightness of the display of the unit.
 Auto: Stays dim only during playback.

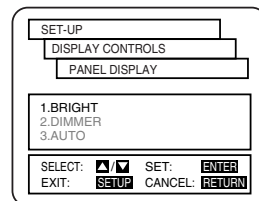
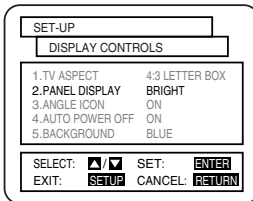

AUDIO SETTINGS

DVD

1 Press the SETUP button in STOP mode.

- The setup screen will appear.

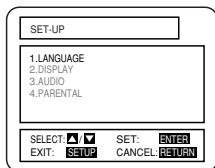

2 Press the Arrow buttons (▲/▼) to select Audio and then press the ENTER button.

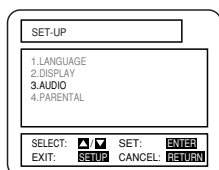

3 Press the Arrow buttons (▲/▼) to select an item, and then press the ENTER button.

Down Sampling (Default: AUTO)

Set the output for the DVD recorded in PCM 96 kHz (96 kHz or 48 kHz)

- Press the Arrow buttons (▲/▼) to select an item, and then press the ENTER button.

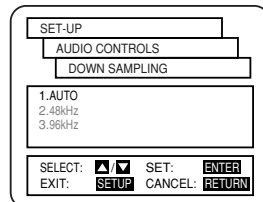
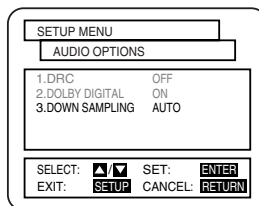

When playing a disc with copyright protection

- If you select 96 kHz, copyright protection will be activated and no sound will come out. If you select AUTO, sound will be down sampled at 48 kHz.

4 Press the SETUP button.

- The setup mode will be canceled and the ordinary screen will appear.

DRC (Default: OFF)

On: DRC

(Dynamic Range Control)

- This function is for controlling the range of sound volume. By compressing the range of sound volume, it is possible not only to suppress the output of loud sound at night and but also to raise the volume of low sound.
- This function is effective only for the sound recorded by Dolby Digital recording.

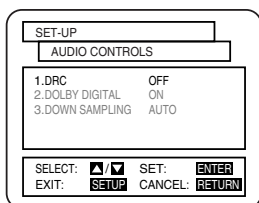

Dolby Digital (default: ON)

On : Output by Dolby Digital

Set to On when the unit is connected to a Dolby Digital Decoder.

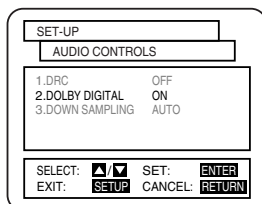

PARENTAL LOCK

DVD

1 Press the SETUP button in STOP mode.

- The setup screen will appear.

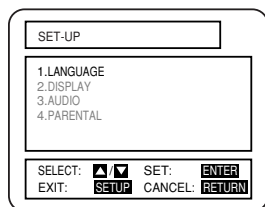

2 Press the Arrow buttons (▲/▼) to select PARENTAL, and then press the ENTER button.

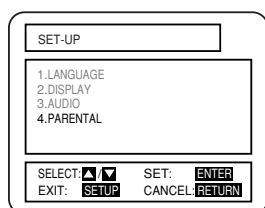

3 Press the Number buttons to enter a 4-digit password (you can use any 4-digits except for 4737), and then press the ENTER button.

- This number will be used as the password from the second time onward.
- By entering the password, you can then change the control level and password settings.
- If you want to change the password, select "CHANGE" and enter a new password. Then press the ENTER button.

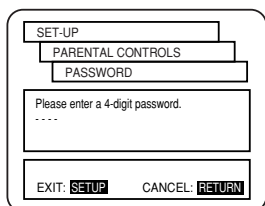

4 Press the Arrow buttons (▲/▼) buttons to select an item, and then press the ENTER button.

When Parental Level is selected

- Press the Arrow buttons (▲/▼) to select an item from "ALL" or 8 to 1 and then press the ENTER button.

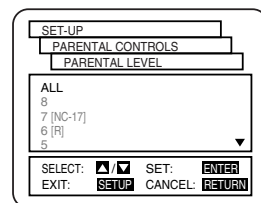
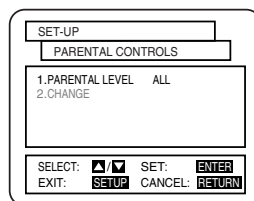

5 Press the SETUP button.

- The setup mode will be canceled and the ordinary screen will appear.

CONTROL LEVELS

- **ALL**
All parental lock is cancelled.
- **Level 8**
DVD software of any grade (adult/general/children) can be played back.
- **Levels 7 to 2**
Only DVD software intended for general use and children can be played back.
- **Level 1**
Only DVD software intended for children can be played back, with those intended for adult and general use prohibited.

Notes

- With some DVDs, it may be difficult to find if they are compatible with parental lock. Be sure to check if the parental lock function operates in the way that you have set.
- Record the password in case you forget it.

IF YOU FORGET THE PASSWORD

- 1) Press 4, 7, 3, and 7 at Step 3.
 - Password will be cleared and parental level will be set to ALL.
- 2) Proceed the above Steps 3-5 again.

LANGUAGE CODE LIST

No.	Language	Country code	No.	Language	Country code
1	Afar	4 7 4 7	69	Latvian; Lettish	5 8 6 8
2	Abkhazian	4 7 4 8	70	Malagasy	5 9 5 3
3	Afrikaans	4 7 5 2	71	Maori	5 9 5 5
4	Amharic	4 7 5 9	72	Macedonian	5 9 5 7
5	Arabic	4 7 6 4	73	Malayalam	5 9 5 8
6	Assamese	4 7 6 5	74	Mongolian	5 9 6 0
7	Aymara	4 7 7 1	75	Moldavian	5 9 6 1
8	Azerbaijani	4 7 7 2	76	Marathi	5 9 6 4
9	Bashkir	4 8 4 7	77	Malay	5 9 6 5
10	Byelorussian	4 8 5 1	78	Maltese	5 9 6 6
11	Bulgarian	4 8 5 3	79	Burmese	5 9 7 1
12	Bihari	4 8 5 4	80	Nauru	6 0 4 7
13	Bislama	4 8 5 5	81	Nepali	6 0 5 1
14	Bengali; Bangla	4 8 6 0	82	Dutch [DUT]	6 0 5 8
15	Tibetan	4 8 6 1	83	Norwegian [NOR]	6 0 6 1
16	Breton	4 8 6 4	84	Occitan	6 1 4 9
17	Catalan	4 9 4 7	85	(Afan) Oromo	6 1 5 9
18	Corsican	4 9 6 1	86	Oriya	6 1 6 4
19	Czech	4 9 6 5	87	Panjabi	6 2 4 7
20	Welsh	4 9 7 1	88	Polish	6 2 5 8
21	Danish [DAN]	5 0 4 7	89	Pashto; Pushto	6 2 6 5
22	German [GER]	5 0 5 1	90	Portuguese [POR]	6 2 6 6
23	Bhutani	5 0 7 2	91	Quechua	6 3 6 7
24	Greek [GRE]	5 1 5 8	92	Rhaeto-Romance	6 4 5 9
25	English [ENG]	5 1 6 0	93	Kirundi	6 4 6 0
26	Esperanto	5 1 6 1	94	Romanian [RUM]	6 4 6 1
27	Spanish [SPA]	5 1 6 5	95	Russian [RUS]	6 4 6 7
28	Estonian	5 1 6 6	96	Kinyarwanda	6 4 6 9
29	Basque	5 1 6 7	97	Sanskrit	6 5 4 7
30	Persian	5 2 4 7	98	Sindhi	6 5 5 0
31	Finnish [FIN]	5 2 5 5	99	Sangho	6 5 5 3
32	Fiji	5 2 5 6	100	Serbo-Croatian	6 5 5 4
33	Faroese	5 2 6 1	101	Singhalese	6 5 5 5
34	French [FRE]	5 2 6 4	102	Slovak	6 5 5 7
35	Frisian	5 2 7 1	103	Slovenian	6 5 5 8
36	Irish [IRI]	5 3 4 7	104	Samoan	6 5 5 9
37	Scots Gaelic	5 3 5 0	105	Shona	6 5 6 0
38	Galician	5 3 5 8	106	Somali	6 5 6 1
39	Guarani	5 3 6 0	107	Albanian	6 5 6 3
40	Gujarati	5 3 6 7	108	Serbian	6 5 6 4
41	Hausa	5 4 4 7	109	Siswat	6 5 6 5
42	Hindi	5 4 5 5	110	Sesotho	6 5 6 6
43	Croatian	5 4 6 4	111	Sundanese	6 5 6 7
44	Hungarian [HUN]	5 4 6 7	112	Swedish [SWE]	6 5 6 8
45	Armenian	5 4 7 1	113	Swahili	6 5 6 9
46	Interlingua	5 5 4 7	114	Tamil	6 6 4 7
47	Interlingue	5 5 5 1	115	Telugu	6 6 5 1
48	Inupiak	5 5 5 7	116	Tajik	6 6 5 3
49	Indonesian	5 5 6 0	117	Thai	6 6 5 4
50	Icelandic [ICE]	5 5 6 5	118	Tigrinya	6 6 5 5
51	Italian [ITA]	5 5 6 6	119	Turkmen	6 6 5 7
52	Hebrew	5 5 6 9	120	Tagalog	6 6 5 8
53	Japanese	5 6 4 7	121	Setswana	6 6 6 0
54	Yiddish	5 6 5 5	122	Tonga	6 6 6 1
55	Japanese [JPN]	5 6 6 9	123	Turkish [TUR]	6 6 6 4
56	Georgian	5 7 4 7	124	Tsonga	6 6 6 5
57	Kazakh	5 7 5 7	125	Tatar	6 6 6 6
58	Greenlandic	5 7 5 8	126	Twi	6 6 6 9
59	Cambodian	5 7 5 9	127	Ukrainian	6 7 5 7
60	Kannada	5 7 6 0	128	Urdu	6 7 6 4
61	Korean [KOR]	5 7 6 1	129	Uzbek	6 7 7 2
62	Kashmiri	5 7 6 5	130	Vietnamese	6 8 5 5
63	Kurdish	5 7 6 7	131	Volapuk	6 8 6 1
64	Kirghiz	5 7 7 1	132	Wolof	6 9 6 1
65	Latin	5 8 4 7	133	Xhosa	7 0 5 4
66	Lingala	5 8 6 0	134	Yoruba	7 1 6 1
67	Laothian	5 8 6 1	135	Chinese [CHI]	7 2 5 4
68	Lithuanian	5 8 6 6	136	Zulu	7 2 6 7

If you choose a Language that has a 3 letter language code, the code will be displayed every time you change the Audio or Subtitle language setting on pages 31 and 32. If you choose any other languages, '---' will be displayed instead. (3 letter language codes are written in square brackets.)

TROUBLESHOOTING GUIDE

If the DVD/VCR does not perform properly when operated as instructed in this Owner's Manual, check the player consulting the following checklist.

D V C R	PROBLEM	CORRECTIVE ACTION
D V C R	No power.	<ul style="list-style-type: none"> • Make sure the power plug is connected to an AC outlet. • Make sure the power is turned on.
	The player does not respond to the remote control.	<ul style="list-style-type: none"> • Check if the power plug is connected to an AC outlet. • Check the batteries in the remote control. • Aim the remote control directly at the remote sensor. If necessary, remove all the obstacles between the sensor and the remote. • You have to be within 7 m of the player. • Check if the correct mode is selected. If not switch the mode by pressing the DVD or the VCR button, whichever you need, on the remote control.
V C R	Timer recording is impossible.	<ul style="list-style-type: none"> • Make sure the timer recording is set correctly. • Make sure the power is off. • Make sure the DVD/VCR clock is set correctly.
	Cannot go into Record mode.	<ul style="list-style-type: none"> • Make sure the tape has a safety tab. If needed, cover the hole with cellophane tape. • Put the player in VCR mode. Press the VCR button on the remote control so that the green VCR OUTPUT light is lit.
	Playback picture is partially noisy.	<ul style="list-style-type: none"> • Adjust tracking control for a better picture by pressing the CHANNEL button (∧/∨) on the DVD/VCR.
	Cannot view a tape but the audio is OK.	<ul style="list-style-type: none"> • Head cleaning may be necessary. Refer to "AUTO HEAD CLEANING". • Make sure the DVD/VCR is not in the Menu mode.
	No, or poor, playback picture.	<ul style="list-style-type: none"> • Select channel 3 or 4 on your TV, then press the VCR/TV button so that the VCR/TV indicator on the VCR comes on. • Fine tune your TV.
	TV programs cannot be seen normally.	<ul style="list-style-type: none"> • Re-check the ANT. IN and ANT. OUT connections. See page 14. • Press the VCR/TV button so that the VCR/TV indicator on the DVD/VCR disappears. • Press the VCR button on the remote control to put it in the VCR mode. Check if the green VCR OUTPUT light is lit. Then, set it to the TV position by pressing the VCR/TV button. The VCR/TV light goes off.
	Video or color fades in and out when making a copy of a video tape.	<ul style="list-style-type: none"> • You cannot copy a copyrighted video tape. You are experiencing copy guard protection.
Cannot remove the tape.	<ul style="list-style-type: none"> • Check if the player is in the VCR mode. If not, press the VCR button on the remote control to switch the mode. 	
D V D	No picture.	<ul style="list-style-type: none"> • Connect the video cables firmly. • Insert a correct video disc that plays on this player. • Press the DVD button on the remote control. Check if the DVD OUTPUT Light is lit. Then try other DVD feature buttons.
	Disc cannot be played.	<ul style="list-style-type: none"> • Insert the disc. • Clean the disc. • Place the disc correctly, with the label side up. • Cancel the parental lock or change the control level.
	No sound.	<ul style="list-style-type: none"> • Connect the audio cables firmly. • Turn the power of the audio component on. • Correct the audio output settings. • Correct the input settings on the audio component.
	Distorted picture.	<ul style="list-style-type: none"> • Connect the player directly to the TV. • There are some cases where pictures may be slightly distorted, which are not a sign of a malfunction. • Although pictures may stop for a moment, this is not a malfunction.
	Audio or subtitle language does not match the set up	<ul style="list-style-type: none"> • The selected language is not available for audio or subtitles on the DVD. This is not a malfunction
	The camera angle cannot be changed.	<ul style="list-style-type: none"> • The DVD does not contain sequences recorded from different camera angles. This is not a malfunction.
	Audio or subtitle language cannot be changed.	<ul style="list-style-type: none"> • The DVD does not contain audio source or subtitles in the selected language. This is not a malfunction.
	"Prohibited icon" appears on the screen, prohibiting an operation.	<ul style="list-style-type: none"> • That operation is prohibited by the player or the disc. This is not a malfunction.

Notes

Some functions are not available in specific modes, but this is not a malfunction. Read the description in this Owner's Manual for details on correct operations.

- Playback from a desired track and random playback are not available during program playback.

HANDLING PRECAUTIONS

SERVICING

Should your DVD/VCR become inoperative, do not try to correct the problem by yourself. There are no user-serviceable parts inside. Turn off, unplug the power cord, and please call our help line at 1-800-242-7158 to locate an Authorized Service Center.

CABINET CLEANING

- Wipe the front panel and other exterior surfaces of the DVD/VCR with a soft cloth immersed in lukewarm water and wrung dry.
- Never use a solvent or alcohol. Do not spray insecticide liquid near the DVD/VCR. Such chemicals may cause damage and discoloration to the exposed surfaces.

AUTO HEAD CLEANING

- Automatically cleans video heads as you insert or remove a cassette, so you can see a clear picture.
 - Playback picture may become blurred or interrupted while the TV program reception is clear. Dirt accumulated on the video heads after long periods of use, or the usage of rental or worn tapes can cause this problem. If a streaky or snowy picture appears during playback, the video heads in your DVD/VCR may need to be cleaned.
1. Please visit your local Audio/Video store and purchase a good quality VHS Video Head Cleaner.
 2. If a Video Head Cleaner does not solve the problem, please call our help line at 1-800-242-7158 to locate an Authorized Service Center.

NOTES:

- Remember to read the instructions included with the video head cleaner before use.
- Clean video heads only when problems occur.

IF THE LASER OPTICAL PICKUP UNIT IS DIRTY

- If the player still does not perform properly when it is operated while referring to the relevant sections and to the TROUBLESHOOTING GUIDE in this Owner's Manual, the laser optical pickup unit may be dirty. Consult your dealer or an Authorized Service Center for inspection and cleaning of the laser optical pickup unit.

DISC HANDLING

- Use discs which have the following logos on them. (Optical audio digital discs.)



- Handle the discs so that fingerprints and dust do not adhere to the surfaces of the discs.

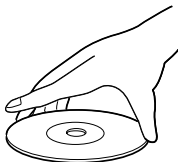
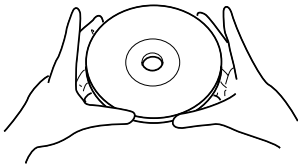

- Always store the disc in its protective case when it is not used.

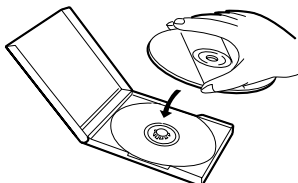

- To clean-off, use a soft cloth.
- Do not use a hard cloth since this will mar the disc.
- Wipe the disc in a straight line from center to edge.
- Never wipe with a circular motion.

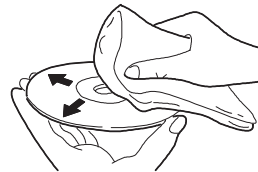

- Do not use detergent or abrasive cleaning agents.

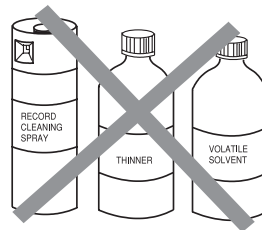

SPECIFICATIONS

Product type:	DVD player with Video Cassette Recorder
Discs:	DVD video Audio CD Video Cassette tape
Converter output:	VHF Channel 3 or 4.
Power source:	120 V AC +/- 10%, 60 Hz +/- 0.5%
Power consumption:	25 W (standby: 7.2 W)
Operating temperature:	5°C to 40°C
Dimensions:	W 17-1/8" (435 mm) H 4" (99 mm) D 10-1/2" (266 mm)
Weight:	8.8 lbs (4 kg)

- **Designs and specifications are subject to change without notice.**
- **If there is a discrepancy between languages, the default language will be English.**

CONTROLES DEL FUNCIONAMIENTO Y SUS FUNCIONES

PANEL DELANTERO

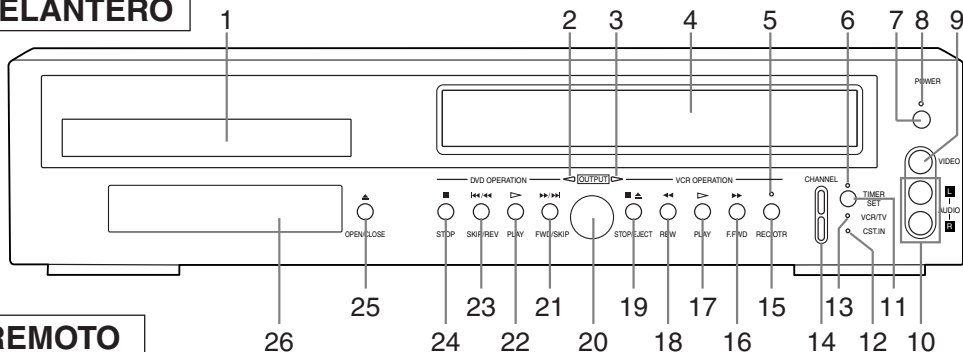

PANEL REMOTO

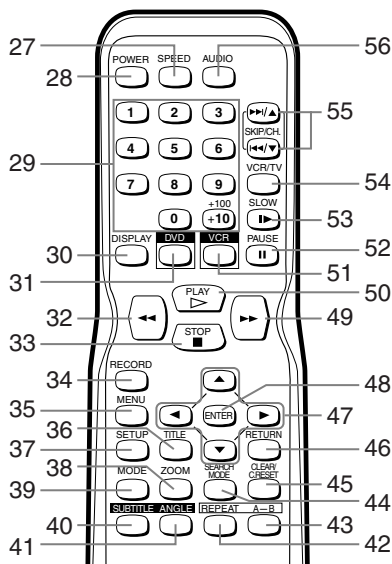

1. Bandeja de carga del disco

2. Luz DVD OUTPUT (verde)

Esta luz aparece cuando el DVD/VCR está en modo DVD. Usted sólo puede mirar DVDs cuando la Luz DVD OUTPUT verde está encendida. Para hacer que la Luz DVD OUTPUT verde se encienda, presione el Botón DVD en el control remoto o el Botón OUTPUT en el panel delantero.

3. Luz VCR OUTPUT (Verde)

Esta luz aparece cuando el DVD/VCR está en el modo VCR. Usted puede sólo mirar cintas cuando la Luz VCR OUTPUT verde está encendida. Para hacer que la Luz VCR OUTPUT verde se encienda, presione el Botón VCR en el control remoto o el Botón OUTPUT en el panel delantero.

4. CASSETTE COMPARTMENT

5. Luz REC/OTR

Se enciende durante la grabación.

6. Luz TIMER SET

Esta luz brilla cuando el DVD/VCR está en el modo espera o apagada para una grabación con temporizador o durante una grabación de Un-Toque. Parpadea si se presiona Botón TIMER SET para una grabación con temporizador, pero no hay cinta en el DVD/VCR. Parpadea cuando todas las grabaciones con temporizador o grabaciones de Un-Toque han terminado.

7. Botón POWER

Presione para conectar y desconectar la alimentación.

8. Luz POWER

Se enciende cuando la alimentación está conectada.

9. Toma VIDEO IN

Conecte aquí un cable de vídeo procedente de la toma de salida de vídeo de un camcorder, otro VCR o una fuente de vídeo (reproductor de discos láser, camcorder, etc.).

10. Tomas AUDIO IN

Conecte aquí cables de audio procedentes de las tomas de salida de audio de un camcorder, otro VCR o una fuente de audio.

11. Botón TIMER SET

Presione para poner el DVD/VCR en modo de espera para una grabación con temporizador.

12. Luz CASSETTE IN

Se enciende cuando un cassette está en el DVD/VCR.

13. Luz VCR/TV

Se enciende cuando el DVD/VCR está en la posición VCR, y se apaga cuando está en la posición TV.

14. Botones CHANNEL

En el modo VCR, presione para cambiar canales TV en el DVD/VCR; presione para ajustar el seguimiento durante reproducción de movimiento normal o lento; presione para remover fluctuaciones verticales en una imagen fija.

15. Botón REC/OTR (VCR)

Presiones una vez para iniciar una grabación. Presione repetidamente para iniciar una grabación de Un-Toque.

16. Botón FWD (VCR)

Presione para avanzar rápidamente la cinta o ver la imagen rápidamente en avance durante reproducción. (Búsqueda en Avance). Cuando ajuste programa. (Por ejemplo: ajuste reloj o programa con temporizador), presione para determinar su selección y proceder al siguiente paso que usted desea entrar. Presione para determinar los modos de ajuste del menú en pantalla. Presione para añadir o cancelar números de canal durante preajuste de canal.

17. Botón PLAY (VCR)

Presione para comenzar reproducción. Presione para entrar dígitos cuando ajuste programa. (Por ejemplo: ajuste reloj o programa con temporizador). Presione para seleccionar los modos de ajuste del menú en pantalla.

18. Botón REW (VCR)

Presione para rebobinar la cinta o para ver la imagen rápidamente en inversión durante el modo de reproducción. (Búsqueda en Rebobinado). Presione para cancelar un ajuste de programa con temporizador. Presione para corregir dígitos cuando ajuste programa. (Por ejemplo: ajuste de reloj o programa con temporizador). Presione para añadir o cancelar números de canal durante preajuste de canal.

19. Botón STOP/EJECT (VCR)

● Botón de expulsión

Púselo para sacar el videocasete de la videograbadora.

● Botón Stop

Presione detener el movimiento de la cinta.

Presione para entrar dígitos cuando ajuste programa. (Por ejemplo: ajuste reloj o programa con temporizador). Presione para seleccionar los modos de ajuste del menú en pantalla.

20. **Botón OUTPUT**

Presione para seleccionar el modo DVD o el modo VCR.

● Usted puede cambiar el modo de salida ya presionando el Botón OUTPUT en el panel delantero o ya presionando el Botón DVD o VCR en el control remote. Sin embargo, si usted presiona el Botón OUTPUT en el panel delantero primero, usted necesita volver a seleccionar el modo correspondiente presionando el Botón DVD o el Botón VCR en el control remote.

21. **Botón FWD/SKIP (DVD)**

Reproduce desde el inicio del siguiente capítulo o pista. Retenga abajo para avanzar rápidamente la reproducción.

22. **Botón PLAY (DVD)**

Comienza la reproducción del contenido del disco.

23. **Botón SKIP/REV (DVD)**

Reproduce desde el inicio del capítulo o pista actual. Retenga abajo para reproducción inversa rápida.

24. **Botón STOP (DVD)**

Detiene la operación del disco.

25. **Botón OPEN/CLOSE**

Presione para insertar discos en o removerlos de la bandeja de disco.

26. **Ventanilla de Sensor Remoto, Visualización**

27. **Botón SPEED**

Presiona para seleccionar la velocidad de grabación de VCR (SP o SLP)

28. **Botón POWER**

Presione para conectar y desconectar la alimentación.

29. **Botones numéricos**

● **Modo DVD**

Presione para seleccionar directamente una Pista (CD de Audio) para reproducción.

Presione para programar Pistas (Dcde Audio) para reproducir.

● **Modo VCR**

Presione para seleccionar canales de TV en el DVD/VCR. Para seleccionar canales, entre números de canal como un número de dos dígitos para los resultados más rápidos. Por ejemplo, para seleccionar canal 6, presione 0.6.

Botón +100:

Si usted desea seleccionar canales 100 y arriba, presione este Botón primero, luego presione los dos dígitos últimos. Por ejemplo, para seleccionar canal 125, presione Botón "+100" primero, luego presione "2" y "5".

30. **Botón DISPLAY**

● **Modo DVD**

Presione para tener acceso o remover la pantalla de visualización durante reproducción DVD o CD de audio.

● **Modo VCR**

Presione para tener acceso o remover visualización de estado en pantalla de VCR.

31. **Botón DVD**

Presione antes de utilizar el control remote para funciones DVD.

32. **Botón ◀◀**

● **Modo DVD**

Presione para ver la imagen DVD en movimiento de inversión rápida o para invertir la reproducción de un DC de Audio.

● **Modo VCR**

Presione para rebobinar la cinta o para ver la imagen rápidamente en inversión durante el modo de reproducción. (Búsqueda en Rebobinado). Presione para cancelar un ajuste de programa con temporizador. Presione para corregir dígitos cuando ajuste programa. (Por ejemplo: ajuste de reloj o

programa con temporizador). Presione para añadir o cancelar números de canal durante preajuste de canal.

33. **Botón Stop**

Presione detener el movimiento de la cinta. Presione para entrar dígitos cuando ajuste programa. (Por ejemplo: ajuste reloj o programa con temporizador). Presione para seleccionar los modos de ajuste del menú en pantalla.

34. **Botón RECORD**

Presione para iniciar una grabación. O, presione repetidamente para iniciar una grabación de Un-Toque.

35. **Botón MENU**

● **Modo DVD**

Presione para visualizar el menú del Disco.

● **Modo VCR**

Presione para tener acceso al menú VCR.

36. **Botón TITLE**

37. **Botón SETUP**

Presione para entrar el modo de preparación.

38. **Botón ZOOM**

Amplía parte de una imagen reproducida-DVD.

39. **Botón MODE**

Activa modo de reproducción de programa o reproducción aleatoria cuando se reproducen CDs o MP3. Ajusta Nivel de negro.

40. **Botón SUBTITLE**

Presione para seleccionar un idioma de subtítulo deseado.

41. **Botón ANGLE**

Presione para cambiar el ángulo de cámara para ver la secuencia que se está reproduciendo desde un ángulo diferente.

42. **Botón REPEAT**

Repite la reproducción del disco, título, capítulo o pista actual.

43. **Botón A-B REPEAT**

Repite la reproducción de una sección seleccionada.

44. **Botón SEARCH MODE**

● **Modo DVD**

Presione para tener acceso o remover la indicación de búsqueda, que le permite ir directamente a un Título/Capítulo/Pista/Tiempo especificado.

● **Modo VCR**

Presione para avanzar o rebobinar rápidamente la cinta a una longitud específica de tiempo.

45. **Botón CLEAR/C.RESET**

● **Modo DVD**

Presione para reponer el ajuste.

● **Modo VCR**

Presione para reponer el contador. Presione para salir de la pantalla MEMU.

46. **Botón RETURN**

Vuelve a la operación previa.

47. **Botones de flecha**

Utilice cuando haga ajustes mientras mira la indicación en una pantalla de TV.

48. **Botón ENTER**

Presione para aceptar un ajuste.

49. **Botón ▶▶**

● **Modo DVD**

Presione para avanzar rápidamente el Disco. Presione el Botón PAUSE, luego presione el Botón FWD iniciar a reproducción en movimiento lento. Presione el Botón FWD repetidamente para cambiar la velocidad de avance del movimiento lento.

● **Modo VCR**

Presione para avanzar rápidamente la cinta o ver la imagen rápidamente en avance durante reproducción. (Búsqueda en Avance). Cuando ajuste programa. (Por ejemplo: ajuste reloj o programa con

temporizador), presione para determinar su selección y proceder al siguiente paso que usted desea entrar. Presione para determinar los modos de ajuste del menú en pantalla. Presione para añadir o cancelar números de canal durante preajuste de canal.

50. Botón PLAY

Presione para comenzar reproducción. Presione para entrar dígitos cuando ajuste programa. (Por ejemplo: ajuste reloj o programa con temporizador). Presione para seleccionar los modos de ajuste del menú en pantalla.

51. Botón VCR

Presione antes de utilizar el control remoto para funciones de VCR.

52. Botón PAUSE

● Modo DVD

Presione para pausar la reproducción de Disco. Presione repetidamente para avanzar la imagen DVD paso a paso (o un fotograma cada vez).

● Modo VCR

Mientras graba, presione para detener provisionalmente la grabación (pausa). Presione por segunda vez para reanudar la grabación normal. Usted no puede pausar Grabación de Un-Toque. O, presione durante la reproducción de cinta para congelar la imagen.

53. Botón SLOW

Durante la reproducción de cinta, presione mirar la cinta de vídeo a movimiento lento. Presione de nuevo para reanudar la reproducción normal. Este Botón no afecta la reproducción DVD.

54. Botón VDR/TV

Utilice para seleccionar la posición VCR o TV. Si la Luz VCR/TV aparece en la parte delantera del DVD/VCR, está en la posición VCR (en cualquier modo VCR o DVD). Si la Luz VCR/TV no aparece en la parte delantera del DVD/VCR, está en la posición TV.

● Posición VCR

Cuando la Luz VCR OUTPUT verde aparece en la parte delantera del DVD/VCR, utilice la VCR para mirar una cinta, para mirar un programa de TV mientras lo graba o para mirar una radiodifusión de TV utilizando los botones CHANNEL o Numéricos para cambiar canales en la DVD/VCR.

Cuando la Luz DVD/VCR aparece en la parte delantera de la DVD/VCR, utilice el DVD/VCR para mirar la reproducción de Disco o menús.

● Posición de TV

Utilice para mirar TV (cambiando canales en el TV) o para mirar un programa mientras graba otro.

55. Botones SKIP/CH

● Modo DVD

Presione para saltar Capítulos o Pistas.

● Modo VCR

Presione para cambiar canales de TV en la DVD/VCR.

56. Botón AUDIO

Presione para seleccionar un idioma de audio deseado o modo de sonido.

Notas

- Para utilizar el control remoto para operar el DVD/VCR y sus funciones, presione el Botón DVD en el control remoto antes de presionar otros botones DVD. Verifique que la Luz DVD OUTPUT verde está encendida.
- Para utilizar el control remoto para operar la VCR y sus funciones, presione el Botón VCR en el control remoto antes de presionar otros botones VCR. Verifique que la Luz VCR OUTPUT verde está encendida.

VISIÓN TRASERA

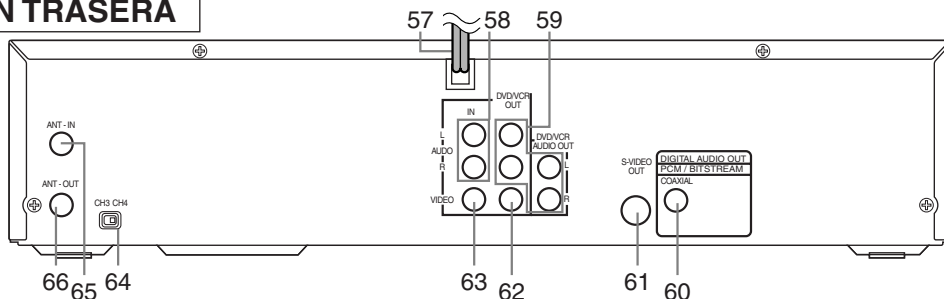

57. Cordón de Alimentación AC

Conecte a una toma de corriente AC estándar para suministrar corriente al DVD/VCR.

58. Tomas AUDIO IN

Conecte aquí los cables de audio procedentes de las tomas de salida de audio de un camcorder, otra VCR o una fuente de audio.

59. Tomas DVD/VCR AUDIO OUT

Conecte aquí los cables de audio provistos y a las tomas de entrada de audio de un televisor u otro equipo de audio.

60. Toma COAXIAL

Conecte aquí un cable de audio digital coaxial opcional y a la toma de entrada Audio Digital Coaxial de un descodificador o receptor de audio.

61. Toma S-VIDEO OUT

Conecte aquí un cable de S-Videó opcional y a la toma de entrada de S-Videó de un televisor.

62. Toma DVD/VCR VIDEO OUT

Conecte aquí el cable de vídeo amarillo (provisto) y a la toma de entrada de Videó de TV.

63. Toma VIDEO IN

Conecte un cable procedente de la toma de salida de vídeo de un camcorder, otra VCR o una fuente de audiovisual (reproductor de disco láser, reproductor de disco de vídeo, etc.) aquí.

64. Cambio CH3/CH4

Ajuste a canal 3 ó 4 para utilizar su TV con su DVD/VCR.

65. Toma ANTI-IN (Entrada de Antena)

Conecte su antena o cable aquí.

66. Toma ANT-OUT (Salida de Antena)

Utilice el cable coaxial RF provisto para conectar esta toma a la Toma ANTENNA IN en su TV.

Caja de cables o Sistema de Radiodifusión Directa.

Notas

- La toma S-VIDEO OUT, toma COAXIAL, toma OPTICAL son sólo útiles en el modo DVD.

CAMBIO DE VCR/DVD

Como este producto se utiliza del reproductor VCR y DVD, es necesario cambiar uno del otro.

CAMBIO AL MODO VCR

Presione el Botón VCR en el control remoto.
(Verifique que la Luz VCR OUTPUT está encendida.)

CAMBIO AL MODO DVD

Presione el Botón DVD en el control remoto.
(Verifique que la Luz DVD OUTPUT está encendida.)

Notas

- Presionando sólo el Botón OUTPUT en el panel delantero no cambia el modo del control remoto. Usted siempre necesita seleccionar el modo correcto en el control remoto, también.

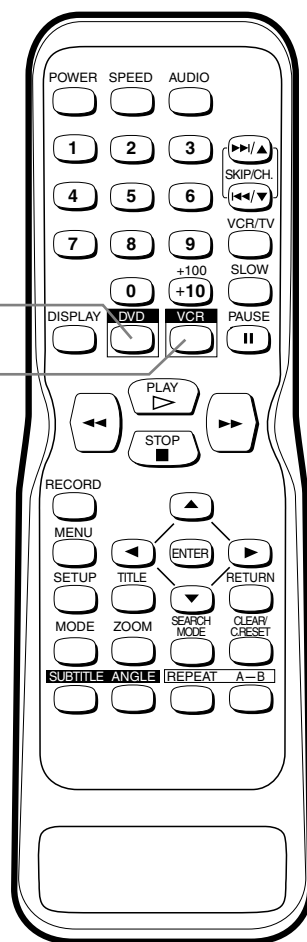
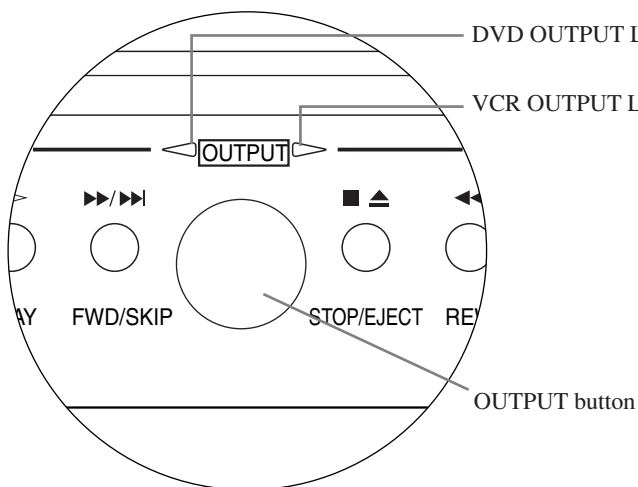
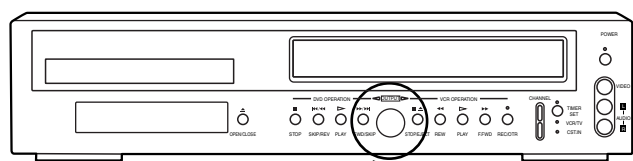

CONEXIONES

DVD/VCR A CONEXIÓN DE TV

1. Desconecte el cordón de alimentación AC del toma de corriente AC.
2. Desconecte la antena o cable del TV.
3. Conecte la antena o cable a la toma ANT.IN del DVD/VCR.
4. Conecte el DVD/VCR al TV utilizando el cable coaxial.
5. Enchufe los cordones de alimentación CA del DVD/VCR y TV dentro de las tomas de corriente AC.

AJUSTANDO EL CONMUTADOR CH3/CH4

Si su TV no tiene terminales A/V:

Cuando el DVD/VCR está en modo de Reproducción VCR o cuando el DVD/VCR está en el modo VCR, su TV recibirá señales del DVD/VCR en cualquiera de los canales 3 ó 4. Para utilizar el DVD/VCR con su TV, ponga el conmutador selector en CH3 o CH4 (que está ubicado en la parte trasera de su DVD/VCR), cualquiera no se utilice para radiodifusiones normales en su área. Luego, ajuste su TV al mismo canal.

CONECTANDO A UN TV

Por favor, vea la [Fig.1] en la página 14 para detalles.

CONECTADO A UN TV QUE TIENE TOMA DE ENTRADA DE S-VIDEO o TOMAS DE ENTRADA DE VIDEO COMPONENTE

Por favor, vea la [Fig. 2] en la página 14 para detalles.

CONECTANDO A UN AMPLIFICADOR EQUIPADO CON TOMAS DE ENTRADA DIGITAL, TALES COMO PLATINA MD O PLATINA DAT

Por favor, vea la [Fig. 4] en la página 15 para detalles.

CONECTANDO A UN DESCODIFICADOR DIGITAL DOLBY

Por favor, vea la [Fig. 5] en la página 16 para detalles.

CONECTANDO A UN AUDIO ANALÓGICO

Por favor vea la [Fig. 6] en la página 16 para detalles.

PREPARACIÓN

PREPARACIÓN DE CANAL AUTOMÁTICA

VCR

- 1 Conecte el TV y ponga el TV en el canal 3 ó 4.
- 2 Conecte el DVD/VCR presionando [POWER]. Ambas Luces POWER y VCR/TV se encenderán.
- 3 Seleccione el Idioma en la pantalla (“INGLÉS”, “FRANCÉS” o “ESPAÑOL”) presionando [PLAY] o [STOP]. Luego, presione [F.FWD].
- 4 Inicie canal preajustado presionando [F.FWD] una vez. El sintonizador explora y memoriza todos los canales activos de su área.
- 5 Después de explorar, el sintonizador de detiene en el canal memorizado más bajo. La pantalla de TV retorna al modo TV.

PREPARACIÓN DE RELOJ

VCR

Ajuste el reloj con precisión para grabación con temporizador automática adecuada. Le sugerimos que usted utilice un TV o estación de radio como su fuente de tiempos.

1 Presione [MENU] dos veces para llamar el menú principal. (Si usted ha ajustado ya el reloj, usted sólo tiene que presionarlo una vez).

- Si el reloj no está ajustado, aparece primero el menú CLOCK SET. En este caso, siga el paso [3].

2 Seleccione "CLOCK SET" presionando [PLAY] o [STOP]. Luego, presione [F.FWD]

3 Ajuste el reloj.

1) Ajuste el mes

Presione [PLAY] o [STOP] repetidamente. Luego, presione [F.FWD].

2) Ajuste el día

Presione [PLAY] o [STOP] repetidamente. Luego, presione [F.FWD].

3) Ajuste el año

Presione [PLAY] o [STOP] repetidamente. Luego, presione [F.FWD].
El día de la semana aparecerá automáticamente.

4) Ajuste la hora

Presione [PLAY] o [STOP] repetidamente. Luego, presione [F.FWD].

5) Ajuste el minuto

Presione [PLAY] o [STOP] repetidamente. Luego, presione [F.FWD].

6) Ajuste el AM o PM

Presione [PLAY] o [STOP] repetidamente.

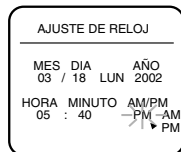

- Para retroceder un paso, presione [REW]

4 Ponga en marcha el reloj presionando [CLEAR/C.RESET] o [F.FWD].

REPRODUCCIÓN DE UN DISCO

REPRODUCIENDO UN DVD, VIDEO O UN CD AUDIO

DVD

CD

Para empezar

Conecte la alimentación del TV, amplificador y cualquier otro componente que se encuentre conectado al DVD/VCR. (Cambie el sistema de entrada para que se adapte DVD/VCR y compruebe que el volumen de sonido sea correcto).

1 Presione el Botón POWER.

- La alimentación se conectará.

Compruebe que la Luz DVD OUTPUT está encendida. Si no, presione el Botón DVD en el control remote para cambiar el modo DVD/VCR.

2 Presione el Botón OPEN/CLOSE.

- La bandeja de carga del disco se abrirá.

3 Ponga un disco en la bandeja.

- Asegúrese de que el disco está asentado correctamente, con el lado de la etiqueta arriba.

4 Presione el Botón PLAY.

- La bandeja se cerrará automáticamente, y la reproducción empezará luego desde el primer capítulo o pista del disco. Usted necesita presionar el Botón PLAY sólo cuando la bandeja se ha cerrado presionando el Botón OPEN/CLOSE.

5 Presione el Botón STOP para detener la reproducción.

FUNAI CORPORATION LIMITED WARRANTY

FUNAI CORP. will repair this product, free of charge in the USA in the event of defect in materials or workmanship as follows:

DURATION:

PARTS: FUNAI CORP. will provide parts to replace defective parts without charge for one (1) year from the date of original retail purchase. Two (2) years for Picture Tube. Certain parts are excluded from this warranty.

LABOR: FUNAI CORP. will provide the labor without charge for a period of ninety (90) days from the date of original retail purchase.

LIMITS AND EXCLUSIONS:

This warranty is extended only to the original retail purchaser. A purchase receipt or other proof of original retail purchase will be required together with the product to obtain service under this warranty.

This warranty shall not be extended to any other person or transferee.

This warranty is void and of no effect if any serial numbers on the product are altered, replaced, defaced, missing or if service was attempted by an unauthorized service center. This FUNAI CORPORATION Limited warranty does not apply to any product not purchased and used in the United States.

This warranty only covers failures due to defects in material or workmanship which occurs during normal use. It does not cover damage which occurs in shipment, or failures which are caused by repairs, alterations or product not supplied by FUNAI CORP., or damage which results from accident, misuse, abuse, mishandling, misapplication, alteration, faulty installation, improper maintenance, commercial use such as hotel, rental or office use of this product or damage which results from fire, flood, lightning or other acts of God.

THIS WARRANTY DOES NOT COVER PACKING MATERIALS, ANY ACCESSORIES (EXCEPT REMOTE CONTROL), ANY COSMETIC PARTS, COMPLETE ASSEMBLY PARTS, DEMO OR FLOOR MODELS.

FUNAI CORP. AND ITS REPRESENTATIVES OR AGENTS SHALL IN NO EVENT BE LIABLE FOR ANY GENERAL, INDIRECT OR CONSEQUENTIAL DAMAGES ARISING OUT OF OR OCCASIONED BY THE USE OF OR THE INABILITY TO USE THIS PRODUCT. THIS WARRANTY IS MADE IN LIEU OF ALL OTHER WARRANTIES, EXPRESS OR IMPLIED, AND OF ALL OTHER LIABILITIES ON THE PART OF FUNAI. ALL OTHER WARRANTIES INCLUDING THE WARRANTY OF MERCHANTABILITY, AND FITNESS FOR A PARTICULAR PURPOSE, ARE HEREBY DISCLAIMED BY FUNAI AND ITS REPRESENTATIVES IN THE UNITED STATES.

ALL WARRANTY INSPECTIONS AND REPAIRS MUST BE PERFORMED BY A FUNAI AUTHORIZED SERVICE CENTER. THIS WARRANTY IS VALID WHEN THE UNIT IS CARRIED-IN TO FUNAI AUTHORIZED SERVICE FACILITY.

IMPORTANT:

THIS LIMITED WARRANTY GIVES YOU SPECIFIC LEGAL RIGHTS, YOU MAY HAVE OTHER RIGHTS THAT VARY FROM STATE TO STATE, IF, AT ANY TIME DURING THE WARRANTY PERIOD, YOU ARE UNABLE TO OBTAIN SATISFACTION WITH THE REPAIR OF THIS PRODUCT, PLEASE CONTACT FUNAI CORP.

ATTENTION:

FUNAI CORP. RESERVES THE RIGHT TO MODIFY ANY DESIGN OF THIS PRODUCT WITHOUT PRIOR NOTICE.

To locate your nearest FUNAI Authorized Service Center or for general service procedure, please call 1-800-242-7158 or write to the following:

FUNAI CORPORATION

Customer Service

100 North Street; Teterboro, NJ 07608

Tel :1-800-242-7158

PLEASE DO NOT SHIP YOUR UNIT TO THE TETERBORO ADDRESS.